

FRAMING SUPPLIES



Glass by **DECOR** & **TRU VUE**

All Glass on page 2 combines for quantity prices.

DECOR Crystal Clear™-2 mm Glass

Float glass washed, polished and paper packed. Ready to Use.

Item #	Size	# of Lites	List	3+ boxes 12% discount	5+ boxes 17% discount
400810	8 x 10	90			
408511	8-1/2 x 11	77			
401114	11 x 14	47			
401216	12 x 16	38			
401418	14 x 18	29			
401620	16 x 20	23			
401824	18 x 24	17			
402024	20 x 24	15			
402228	22 x 28	12			
402430	24 x 30	10			
402436	24 x 36	8			
402632	26 x 32	9			
402636	26 x 36	8			
402838	28 x 38	7			
403036	30 x 36	7			
403040	30 x 40	6			
403240	32 x 40	6			
403248	32 x 48	5			
403648	36 x 48	4			
404048	40 x 48	4			

DECOR Crystal Clear™-2.5 mm Glass

Float glass washed, polished and paper packed. Ready to Use.

Item #	Size	# of Lites	List	3+ boxes 12% discount	5+ boxes 17% discount
404060	40 x 60	3 lites, not 2			

Compare & Save vs. the others

DECOR Extra Clear™-2.5 mm Glass

Washed, polished and paper packed. Ready-for-use.
Blocks 45% UV, light transmission of 90%. 50 sq. ft/box

Item #	Size	# of Lites	List	3+ boxes 12% discount	5+ boxes 17% discount
411216	12 x 16	38			
411418	14 x 18	29			
411620	16 x 20	23			
411824	18 x 24	17			
412024	20 x 24	15			
412228	22 x 28	12			
412430	24 x 30	10			
412436	24 x 36	8			
412632	26 x 32	9			
412636	26 x 36	8			
412838	28 x 38	7			
413036	30 x 36	7			
413040	30 x 40	6			
413240	32 x 40	6			
413648	36 x 48	4			
414060	40 x 60	3 lites, not 2			

DECOR Non-Glare Glass

Single side etch non-glare. Greater clarity than double-sided etch.
Blocks 45% UV, light transmission of 90%. 50 sq. ft/box

Item #	Size	# of Lites	List	3+ boxes 12% discount	5+ boxes 17% discount
511620	16 x 20	23			
512024	20 x 24	15			
512228	22 x 28	12			
512430	24 x 30	10			
512436	24 x 36	8			
513036	30 x 36	7			
513040	30 x 40	6			
513240	32 x 40	6			
513648	36 x 48	4			
514060	40 x 60	3 lites, not 2			

TRU VUE Reflection Control

Single side etch non-glare. Greater clarity than double-sided etch.
Blocks 53% UV, light transmission of 90%. 50 sq. ft/box

Item #	Size	# of Lites	List	3+ boxes 12% discount	5+ boxes 17% discount
421620	16 x 20	23			
421824	18 x 24	17			
422436	24 x 36	8			
422632	26 x 32	9			
423240	32 x 40	6			
423648	36 x 48	4			
424060	40 x 60	2			

TRU VUE Premium Clear 2.5mm Glass

Washed, polished and paper packed. Ready-to-use.
45% UV blocking, 90% light transmission. 50 sq. ft/box

Item #	Size	# of Lites	List	3+ boxes 12% discount	5+ boxes 17% discount
521418	14 x 18	29			
521620	16 x 20	23			
521824	18 x 24	17			
522024	20 x 24	15			
522228	22 x 28	12			
522436	24 x 36	8			
523240	32 x 40	6			
523648	36 x 48	4			
524060	40 x 60	3			

FLETCHER Running/Nipping Pliers



For cut-running and break-out of glass up to 1/4" thick. Comfort contoured handles. Lightweight fibre reinforced for extra strength. Complete with interchangeable heads for running (break out) and nipping.

Item #	Description	Price
F06111	<input checked="" type="checkbox"/> 6" Nipping/Running Plier; 3/4" jaw	
F06112	<input checked="" type="checkbox"/> 8" Nipping/Running Plier; 1" jaw	

Crystal Clear™ 2.5mm Palletized Float Glass is available from both locations. Call for pricing.

Glass Cutters: pg 6 Glass Cleaners: pg 7 Acrylic Cutter: pg 6

Glass on this page COMBINES for QUANTITY DISCOUNTS

TRU VUE UltraVue® Anti-Reflection Water White Glass

98.5% light transmission, Blocks 70% of UV light, < 1% light reflection. Scratch resistant, anti-static.

Item #	Size	# of Lites	List	3+ boxes 5% discount	5+ boxes 8% discount
491620	16 x 20	12			
492436	24 x 36	4			
493240	32 x 40	3			
493648	36 x 48	2			
494060	40 x 60	2			
494868	48 x 68	2			

TRU VUE Museum Glass

Blocks 99% of UV light. 97% light transmission. <1% reflection.

Item #	Size	# of Lites	List	3+ boxes 5% discount	5+ boxes 8% discount
481620	16 x 20	16			
481824	18 x 24	12			
482024	20 x 24	11			
482228	22 x 28	8			
482430	24 x 30	7			
482436	24 x 36	6			
483240A	32 x 40	1			
483240	32 x 40	4			
503240	32 x 40	6			
483648	36 x 48	3	50 sq ft/box		
484060	40 x 60	2			
484868	48 x 68	2			

TRU VUE AR Reflection-Free

97% light transmission. <1% reflection. Blocks 78% of UV light

Item #	Size	# of Lites	List	3+ boxes 5% discount	5+ boxes 8% discount
472436	24 x 36	4			
473240	32 x 40	3			
473648	36 x 48	2			
474060	40 x 60	2			

TRU VUE Conservation Clear

Blocks 99% of UV light. 91% light transmission. 8% reflection.

Item #	Size	# of Lites	List	3+ boxes 5% discount	5+ boxes 8% discount
431114	11 x 14	47			
431216	12 x 16	38			
431418	14 x 18	29			
431620	16 x 20	23			
431824	18 x 24	17			
432024	20 x 24	15			
432228	22 x 28	12			
432430	24 x 30	10			
432436	24 x 36	8			
432632	26 x 32	9			
433240	32 x 40	6			
433648	36 x 48	4			
434060	40 x 60	2			
434868	48 x 68	2			

TRU VUE Conservation Reflection Control

Blocks 97% of UV light. 90% light transmission. 8% reflection.

Item #	Size	# of Lites	List	3+ boxes 5% discount	5+ boxes 8% discount
441620	16 x 20	23			
442228	22 x 28	12			
442436	24 x 36	8			
443240	32 x 40	6			
443648	36 x 48	4			

PREMIUM CLEAR FF3 Framing Grade ACRYLIC by Acrylite®

92% light transmission. 66% UV blocking. **SAVE 10%**

Item #	Size / Protection	Thickness	1 sheet	5 shts/item
584896	48x96 / Blue Masking	0.060"		
594896	48x96	0.080"		
603240	32x40	0.090"		
614060	40x60	0.118"		
604896	48x96	0.090"		
674896	48x96	0.098"		
676096	60x96	0.098"		
614896	48x96	0.118"		
634896	48x96 / Paper Mask	0.118"		
616096	60x96	0.118"		
617296	72x96	0.118"		

NON-GLARE - P99 by Acrylite®

92% light transmission. **SAVE 10%**

Item #	Size	Thickness	1 sheet	5 shts/item
663240	32x40	0.098"		
624060	40x60	0.118"		
664896	48x96	0.098"		
624896	48x96	0.118"		

CONSERVATION ACRYLIC-OP3 by Acrylite®

99% UV blocking. 92% light transmission. **SAVE 10%**

Item #	Size	Thickness	1 sheet	5 shts/item
653240	32x40	0.098"		
644060	40x60	0.118"		
654896	48x96	0.098"		
644896	48x96	0.118"		
646096	60x96	0.118"		

CONSERVATION NON-GLARE - OP3 P99 by Acrylite®

99% UV blocking. Non-Glare. 92% light transmission. **SAVE 10%**

Item #	Size	Thickness	1 sheet	5 shts/item
683240	32x40	0.098"		
694060	40x60	0.118"		
684896	48x96	0.098"		
694896	48x96	0.118"		

TRU VUE Optium Museum Acrylic®

• 99% UV protection • Anti-Reflective • Anti-static • Abrasion Resistant

Item #	Size	Thickness	1 sheet
801620	16x20	0.118"	
802024	20x24	0.118"	
802432	24x32	0.118"	
803240	32x40	0.118"	
803648	36x48	0.118" boxed	
804060	40x60	0.118" boxed	
804896	48x96	0.118"	
805296	52x96	0.118"	
816080	60x80	0.177"	
817296B	72x96	0.177" boxed	
8272120B	72x120	0.236" boxed	
817296	72x96	0.177" Min. 10/pallet (special order)	
8272120	72x120	0.236" Min. 5/pallet (special order)	

Optium Acrylic® • 93% UV protection

834896 48x96 0.118"

Trulife Standard Acrylic® 3mm

844896 48x96 0.118"

CUSTOM CUT Acrylic SIZES Call for quantity discounts

Item #	Description	Price/sq. ft.	Item #	Description	Price/sq. ft.
58C	FF3 0.060		68C	OP3 P99 0.098 UV Non-Glare	
59C	FF3 0.080		69C	OP3 P99 0.118 UV Non-Glare	
60C	FF3 0.093		80C	Optium Museum 0.118	
67C	FF3 0.098		81C	Optium Museum 0.177	
61C	FF3 0.118		82C	Optium Museum 0.236	
62C	P99 0.118 Non-Glare		83C	Optium 0.118	
64C	OP3 0.118 UV Blocking				

Example: 1 piece of #60C acrylic 15 1/2" x 32 3/4" equals 4.0 sq. ft.

* Custom Cut TruVue acrylic orders utilizing less than 60% of the sheet will incur a 40% upcharge. Additional packaging may apply.



FOAMBOARD



All Foamboard Boxes Mix 'N Match For Quantity Discounts, except for Artcare & Gator Foam

Single Sheets of Foamboard - see page 63

Single Sheets of Foamboard - see page 63

REGULAR by Gilman INSITE

SAVE 5% SAVE 10%

White clay coated foamboard with Reveal® Foam center. Engineered to retain its thickness during mounting, laminating, die-cutting & screen printing.

Item #	Size	Sheets/Box	1 Box	2 Boxes	3 Boxes
116	3/16" - 20" x 30"	25			
100	3/16" - 24" x 36"	25			
101	3/16" - 30" x 40"	25			
102	3/16" - 32" x 40"	25			
106	3/16" - 36" x 48"	25			
103	3/16" - 40" x 60"	25			
104	3/16" - 48" x 96"	25			
110	1/8" - 32" x 40"	25			
111	1/8" - 40" x 60"	25			
108	3/16" - 60" x 120"	16			

ACID FREE by Gilman INSITE

SAVE 5% SAVE 10%

2-sided protection from damaging pollutants & harmful gases designed for conservation mounting and framing with calcium carbonate are 100% Alpha cellulose virgin pulp.

Item #	Size	Sheets/Box	1 Box	2 Boxes	3 Boxes
130	3/16" - 32" x 40"	25			
131	3/16" - 40" x 60"	25			
133	3/16" - 48" x 96"	25			
135	1/8" - 32" x 40"	25			
138	1/8" - 40" x 60"	25			

HEAT ACTIVATED by Gilman INSITE

SAVE 5% SAVE 10%

Ultra smooth permanent bond. Incorporates acid-free liners with one side coated with permanent (160°) heat-activated pH neutral adhesive.

Item #	Size	Sheets/Box	1 Box	2 Boxes	3 Boxes
117	3/16" - 24" x 36"	25			
113	3/16" - 32" x 40"	25			
118	3/16" - 36" x 48"	25			
114	3/16" - 40" x 60"	25			
119	3/16" - 48" x 96"	25			

BLACK SURFACE WITH BLACK CORE by Gilman INSITE

SAVE 5% SAVE 10%

This rich black paper and foam is flawless and perfectly smooth.

Item #	Size	Sheets/Box	1 Box	2 Boxes	3 Boxes
112	3/16" - 32" x 40"	25			
120	3/16" - 40" x 60"	25			
169	3/16" - 48" x 96"	25			

PRESSURE SENSITIVE by Gilman INSITE

SAVE 5% SAVE 10%

A convenient all-purpose board coated on one side. Just peel back the liner, roll down your print and smooth from the center to the edges for a smooth finish. No glues or sprays are needed.

Item #	Size	Sheets/Box	1 Box	2 Boxes	3 Boxes
109	3/16" - 24" x 36"	25			
115	3/16" - 32" x 40"	25			
107	3/16" - 40" x 60"	25			



Lightweight rigid display board for printing and laminating. Firm and dense polystyrene core with resin impregnated wood fiber surfaces on both sides that is water resistant.

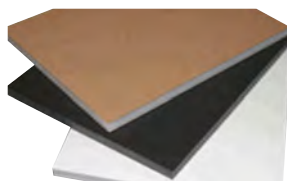

SAVE 15% SAVE 20%

Item #	Size	Color	Core	Shts/Bx	1 Sheet	1 Boxes	3 Boxes
265	3/16"-48" x 96"	White	White	15			
266	3/16"-48" x 96"	Black	Black	15			
267	3/16"-48" x 96"	Kraft	White	15			
268	1/2"-48" x 96"	White	White	12			

REGULAR by Bainbridge

SAVE 5% SAVE 10%

Bright white clay coated ideal for all nonarchival mounting applications where you want crisp, clean cuts. This extra smooth multi-purpose foamboard is lightweight, yet sturdy enough to resist denting.

Item #	Size	Sheets/Box	1 Box	2 Boxes	3 Boxes
150	3/16" - 24" x 36"	25			
152	3/16" - 32" x 40"	25			
153	3/16" - 40" x 60"	25			
154	3/16" - 48" x 96"	25			
155	1/8" - 32" x 40"	25			

ACID FREE by Bainbridge

SAVE 5% SAVE 10%

Features alkaline pH surfaces with superior opacity and consistent surface paper for conservation framing.

Item #	Size	Sheets/Box	1 Box	2 Boxes	3 Boxes
157	3/16" - 32" x 40"	25			
158	3/16" - 40" x 60"	25			
159	1/8" - 32" x 40"	25			
156	3/16" - 48" x 96"	25			

SpeedMount by Bainbridge

SAVE 5% SAVE 10%

Lowest mounting temperature makes dry mounting faster than ever. Works in just seconds (mechanical press: 15 seconds; vacuum press: 2 minutes) and bonds at temperatures as low as 150°.

Item #	Size	Sheets/Box	1 Box	2 Boxes	3 Boxes
125	3/16" - 24" x 36"	25			
126	3/16" - 32" x 40"	25			
127	3/16" - 40" x 60"	25			

BLACK SURFACE WITH BLACK CORE by Bainbridge

SAVE 5% SAVE 10%

Non-reflective satin finish and scuff and scratch resistant.

Item #	Size	Sheets/Box	1 Box	2 Boxes	3 Boxes
160	3/16" - 32" x 40"	25			
161	3/16" - 40" x 60"	25			

ARTCARE ACID-FREE by Bainbridge

MicroChamber® technology, absorbs & neutralizes harmful acidic gases. Alkaline pH surfaces. Paper prevents show-through better than other boards.

Item #	Size	Sheets/Box	1 Box
AC3240	3/16" - 32" x 40"	25	
AC4060	3/16" - 40" x 60"	25	

PICTURE POSTER PRONG HANGER - ZINC PLATED

Use with any board as thin as 3/16" without penetrating to the front. Just push into the board, when flush, push in center prong and it will lock. 1000/box. 13/16" x 3/4".



Item #1872

DECOR MIRRORS

100% Satisfaction Guaranteed

Cleaning Instructions: The safest cleaner for a mirror is clean, warm water used on a soft cloth. **DO NOT** spray any glass cleaner directly on the mirror, instead apply cleaner to a soft cloth and then wipe.

PREMIUM QUALITY 1 1/4" BEVELED MIRRORS

- All Mirrors are washed, polished and ready to frame.
- All Mirrors are individually boxed with plastic protective corners
- Decor Mirrors have painted/sealed backs.
- Framers Choice - 3/16" Highest Quality Mirror.



Item #	Size	Cost Each 1 Mirror	SAVE 20% 4+ Each
M1620	16" x 20"		
M2024	20" x 24"		
M2228	22" x 28"		
M2430	24" x 30"		
M2436	24" x 36"		
M2460	24" x 60"		
M3040	30" x 40"		
M3648	36" x 48"		

PREMIUM QUALITY 1/8" THICK MIRRORS

Individually packaged.

You can cut these mirrors to your own custom size.

Item #	Size	Cost Each 1 Mirror	SAVE 20% 4+ Each
PM2436	24" x 36"		
PM3040	30" x 40"		
PM3240	32" x 40"		
PM3648	36" x 48"		
PM3660	36" x 60"		
PM4060	40" x 60"		

KOOL TACK

Available ONLY from Southern
A 15-20 second heat-activated at 150°-160° acid-free
adhesive pH neutral *Reversible* Foamboard

KOOL TACK REVERSIBLE

SAVE 5%

Item #	Size	Sheets/Box	1 Box	2 Boxes	3 Boxes
140	3/16" - 32" x 40"	25			
144	3/16" - 40" x 60"	25			
143	1/8" - 32" x 40"	25			

KOOL TACK ACID-FREE PRESERVE ULTRA-100% REVERSIBLE

SAVE 5%

Item #	Size	Sheets/Box	1 Box	2 Boxes	3 Boxes
141	3/16" - 32" x 40"	25			

SPRAYWAY™ FAST TACK #87



Maximum strength general purpose adhesive used for both temporary and permanent bonding, **comparable to Super 77**. It's quick initial tack and high solids make it perfect for many papers, metals, foils, plastics, cloths, foams and cardboard. Each can provides appx. 90 sq. ft. of coverage.

Item #	Price	SAVE 10% 12 +
847 <input checked="" type="checkbox"/>		

3M™ SUPER 77 SPRAY ADHESIVE



A strong, translucent, fast drying adhesive formulated for general bonding applications where high bond strength is needed. Attaches foils, cloths, carpet, foams, paper, cardboard, etc. to metals, wood, hard board and other base materials. Gross wt. 24 oz. Net wt. 16.5 oz.

Item #	Price	12 +	24 +
595 <input checked="" type="checkbox"/>			

3M™ 74 FOAM AND FABRIC ADHESIVE



Permanently bonds foam and fabric together or to most other materials like wood, metal and plastic. Dries tack and odor free. Fast tacking with lace like spray pattern. Works well on urethane and latex foams. Gross wt. 23 1/2 oz. Net weight 17 1/4 oz.

Item #	Price	12 +	24 +
658 <input checked="" type="checkbox"/>			

3M™ PHOTO MOUNT SPRAY ADHESIVE



A strong, clear aerosol adhesive specially formulated for mounting photographs, art prints or other material. Just spray the back of print, let dry until tacky and press in position. Gross weight 15 1/2 oz. Net weight 10.25 oz. 3M #6094.

Item #	Price	12 +
597 <input checked="" type="checkbox"/>		

3M™ SPRAYMOUNT Repositionable ADHESIVE



A clear, one-surface aerosol adhesive that provides a repositionable bond on most surfaces. Will not form a permanent bond, is long aging and non-staining. Gross weight 15.25 oz. Net weight 10.25 oz. 3M #6065

Item #	Price	12 +	24 +
596 <input checked="" type="checkbox"/>			

6 DIAMANTOR GLASS CUTTER



ITEM 1 for 12 @
653 ✓

Used for most glass-cutting work as well as various types of stencil-cutting and shape work. Rounded wooden handle. Single alloy-steel wheel. Wheel is not replaceable.

DECOR BALL GLASS CUTTER



General purpose glass cutter for picture and window glass. ITEM 1 for 6 @
896 ✓

RED DEVIL™ BALL GLASS CUTTER



ITEM 1 for 12 @
652 ✓

Highest quality glass cutter. All purpose picture and window glass cutter with ball end.

FLETCHER Gold Tip Ball End Glass Cutter



Cast from superior grade steel. Features "Classic" contoured comfort grip handle in ball end handle style. 130° cutting wheel. ITEM # Price
F01827 ✓

FLETCHER Gold Tip Straight End Glass Cutter



Item 1 for
F01115 ✓

FLETCHER Carbide Wheel Glass Cutter

134° die cast wheel. Ball end.



Item Description 1 for
F01841 ✓ Fletcher Carbide Wheel Glass Cutter

FLETCHER Designer II Fluid Dispensing Glass Cutter



Features a 140° tungsten carbide cutting wheel and the option of fixed or swivel head scoring. Solid brass and clear plastic pistol grip cutter includes a tapping ball for easy break-out of glass.

Item # Description Price
F01715 ✓ Fluid Dispensing Glass Cutter
F03711 ✓ Replacement wide head 140°

RED DEVIL™ HEAVY DUTY PLASTIC CUTTER



Handle design allows for comfortable, natural pressure.

Cut through plastic sheets up to 1/4" thick. Do it easier, cleaner and without fatigue.

Item 1 for
827 ✓

FLETCHER Scorematic Double Edge Plastic Cutter



Designed for scoring acrylics and tile.

Item # Price
F05111 ✓

FLETCHER HEAVY DUTY PLASTIC CUTTER



Handle design allows for comfortable, natural pressure.

Designed for scoring acrylics and tile up to 1/4" thick easier, cleaner and without fatigue. Ergonomically designed comfort grip handle. Replaceable scoring blades available.

Item Description 1 for

F05120 ✓ Fletcher Heavy Duty Plastic Cutter
F05713 ✓ Fletcher replacement Plastic Blades 10/pk

DECOR 6-Wheeled Turret Head Glass Cutter



ITEM 1 for 6 @
897 ✓

FLETCHER 6-Wheeled Turret Head Glass Cutter



Item Description 1 for

F01511 ✓ Fletcher Turret Head Glass Cutter
F02611 ✓ Fletcher replacement wheels

FLETCHER Scoremaster® II Glass Cutter

Features an oil dispensing system that produces a continuous, even flow of oil along the score line and a pencil grip. A "changeable wheel/axle" is available for customers who want flexibility in changing wheel angles for different glass thicknesses.



Item Description 1 for

F01702 ✓ Fletcher Scoremaster II Glass Cutter
F03701 ✓ Fletcher repl head for Score. I & II

FLETCHER Brass Gold Tip Glass Cutter

Solid brass wide cutting head. Pencil grip handle. Complete with a 140° tungsten carbide cutting wheel.



Item Description 1 for

F01712 ✓ Fletcher Brass Gold Tip Glass Cutter
F03711 ✓ Replacement wide head 140°

GLASS CLEANER / Sprayway®



Item # 696

Cleans glass, mirrors and so much more.
19 oz. can.

SAVE 12.5%

1 + 12 +

- Ammonia and Silicone-Free.
- Leaves no film.
- Dries fast.
- Contains NO ozone-depleting chemicals.

GLASS CLEANER / TRU VUE®



#987
32 oz. spray



#988
1 gallon refill

- Ammonia-Free.
- Soap-Free.
- Non-Streaking.
- Static-Free.
- Leaves no residue.
- Ideal for any type of glass.

Item # 1 + 4 +
987
988

GLASS CLEANER by Dirtex®



Item #	Desc.	1 for	12 +	24+
310 <input checked="" type="checkbox"/>	18oz. can			
296 <input checked="" type="checkbox"/>	22oz. spray			



- Cleans glass, mirrors, tile, chrome, porcelain and more.
- Removes dirt, grease and grime.
- Clings to surfaces.
- No streaks or film.
- Ammoniated for fast action.

DUST-OFF™



Kit includes nozzle and 8 oz can. Removes dust from fitted pictures. No disassembly. Controlled blast of air. No marks or smudges.

Cannot be shipped via air

Item #	Desc.	1 for	12 +
1528 <input checked="" type="checkbox"/>	Kit		
1529 <input checked="" type="checkbox"/>	10 oz. refill can		

PLASTIC CLEANER/Sprayway®



Item # 697

Cleans acrylics, plexi, lexan, plastic mirrors, glass and more.
19 oz. can.

SAVE 10%

1 + 12 +

- Anti-static
- Anti-fog
- Fast-drying
- Non-streaking
- Repels dirt, dust and finger smudges

PLASTIC CLEANER & POLISH



Item # 945

1 +

Used by the
Metropolitan Museum of Fine Art,
Kennedy Library
and National Gallery of Art

- Anti-static
- Cleans fast
- Gives material a lustrous look
- Leaves a protective coating that resists fingerprints
- 14 oz.

#1 Plastic Cleaner & Shiner / Novus®



- Gently cleans all plastics without scratching.
- Leaves a lustrous shine that resists fogging, repels dust, and eliminates static.
- Resists finger marking.
- Contains no abrasives or harsh chemicals.
- Leaves a smooth, clean, greaseless shine.

Item # 836 - 8 oz pump bottle

#2 Fine Scratch Remover / Novus®



- Removes fine scratches, haziness and abrasions from most plastics.
- With repeated use, NOVUS #2 restores faded and discolored plastics.
- Removes the damage instead of filling it in.
- Buffs out quickly.
- After restoring, seal with a coat of Novus #1.

Item # 837 - 8 oz bottle

Lint & Dust Remover/Sprayway®



- Ultra-clean moisture-free air blasts away dust, lint, etc.
- Removes dust from fitted pictures.
- Safe to use on all electronic energized equipment.
- Contains NO ozone depleting chemicals.
- **Non-Flammable**
- Cannot ship by Air Freight.
- Net wt. 10 oz.

SAVE 10%

1 + 12 +

Item 698

8 3M HIGHLAND™ 987 ATG TAPE

NET
0.50 in/po x 60 yd/v (12.7 mm x 54.9 m)
Total 720 yd/v (658 m)
0.002 in/po (0.05 mm) Thick/Épais/Grueso/Espezzura

3M

ATG Adhesive Transfer Tape 987
Ruban à transfert d'adhésif 987 ATG
987 Cinta-calcomania adhesiva ATG
Fita de adesivo transferível 987 ATG

CONT.
12 @/ 1/1
0.50 in/po x 60 yd/v (12.7 mm x 54.9 m)
Total 720 yd/v (658 m)
0.002 in/po (0.05 mm) Thick/Épais/Grueso/Espezzura

3M



Two-sided economy adhesive tape. Permanent mounting for photos, mats, foamboards, artwork and similar items.

1" Core 3M #987

Item	Description	Price Ea.	12@	48@	72@	96@	144@
555**	<input checked="" type="checkbox"/> 1/2" x 36 yard roll						
556**	<input checked="" type="checkbox"/> 3/4" x 36 yard roll						
331	<input checked="" type="checkbox"/> 1/2" x 60 yard roll						
332	<input checked="" type="checkbox"/> 3/4" x 60 yard roll						

DECOR PREMIUM ACID-FREE ATG TAPE



The highest quality 2 mil Acid-Free ATG tape. Used for permanent mounting photos, artwork, mats, foamboards & similar materials. This high tack adhesive is equivalent to 3M's finest products at significant savings. Individually packaged. 1" Core

Item	Description	Price Ea.	12 @	48 @	72 @	144 @
315**	<input checked="" type="checkbox"/> 1/2" x 36 yd roll					
313	<input checked="" type="checkbox"/> 1/2" x 60 yd roll					
314	<input checked="" type="checkbox"/> 3/4" x 60 yd roll					

DECOR PREMIUM SUPER ATG TAPE

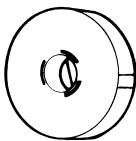

- 5 mil Heavy Duty Acrylic Adhesive
- Permanently bonds to irregular surfaces such as fabrics, foils and textured surfaces.
- Also great for double mats and foamboard.
- Higher initial joining strength and is resistant to water, heat and solvents. 1" Core

Item	Description	Price Ea.	12 @	48 @	72 @
317	<input checked="" type="checkbox"/> 1/2" x 18 yd roll				
318	<input checked="" type="checkbox"/> 3/4" x 18 yd roll				

DECOR PREMIUM HAND HELD ATG TAPE



Wound in reverse, liner is removable by hand. 3" core, 2 mil thick.

COMPARE and SAVE!

No.	Description	Price Ea.	12 @	96 @
319	<input checked="" type="checkbox"/> 3/8" x 60 yd roll			

For hand application.
Will not fit ATG Gun.

- * Can be used in 3M ATG Guns Decor #585 or #586 w/adaptor kit #587
- ** Can be used in Decor #320 & #1516 or 3M ATG Guns Decor #585 & #586
- ◆ Can be used in Decor ATG Gun #320 or 3M 700 ATG Gun Decor #586
- ⊙ Can be used in ALL Decor or 3M ATG Guns.

3M 924 ATG TAPE



3M

LOWEST INDUSTRY PRICES

This 2 mil premium adhesive tape is used for permanent mounting of photos, artwork, mats foamboard and similar materials. Liner is automatically removed when used with ATG dispensers. 1" Core 3M #924

No.	Description	Price Ea.	12 @	48 @	72 @	144 @
552*	<input checked="" type="checkbox"/> 1/4" x 36 yd roll					
553**	<input checked="" type="checkbox"/> 1/2" x 36 yd roll					
554**	<input checked="" type="checkbox"/> 3/4" x 36 yd roll					
588	<input checked="" type="checkbox"/> 1/2" x 60 yd roll					
589	<input checked="" type="checkbox"/> 3/4" x 60 yd roll					

DECOR HI-TAC HEAVY DUTY ATG TAPES



2 mil Hi-Tac permanent acrylic adhesive immediately grips to matboards, foamboards and foils. Just right for double matting, nameplate applications. Ready to bond. Is resistant to heat and solvents. Pkg'd 12/box (1/4" & 1/2"); 8/box (3/4"). 1" Core

Item	Description	Min. 8 or 12 @	48 @	72 @	96 @	144 @
371*	<input checked="" type="checkbox"/> 1/4" x 36 yd roll					
364**	<input checked="" type="checkbox"/> 1/2" x 36 yd roll					
365**	<input checked="" type="checkbox"/> 3/4" x 36 yd roll (min. 8)					
366	<input checked="" type="checkbox"/> 1/2" x 60 yd roll					
367	<input checked="" type="checkbox"/> 3/4" x 60 yd roll (min. 8)					

5 mil Heavy-Duty Hi-Tac permanent acrylic adhesive immediately grips to irregular surfaces such as textured surfaces, foils and fabrics. Just right for double mats and foamboard. Ready to bond. Resistant to heat. Pkg'd 12/box (1/4" & 1/2"); 8/box (3/4"). 1" Core

Item	Description	Min. 8 or 12 @	48 @	72 @	144 @
1409*	<input checked="" type="checkbox"/> 1/4" x 18 yd roll				
368**	<input checked="" type="checkbox"/> 1/2" x 18 yd roll				
369**	<input checked="" type="checkbox"/> 3/4" x 18 yd roll (min. 8)				

DECOR HI-TAC HAND-HELD ATG TAPES

2 mil Heavy-Duty Hi-Tac permanent acrylic adhesive



Wound in reverse, liner is removable by hand. Immediately grips to matboards, foamboards and foils. Is resistant to heat and solvents. 3" core.

No.	Description	Price ea.	12 @	72 @	96 @
1398	<input checked="" type="checkbox"/> 1/4" x 60 yd roll				
370	<input checked="" type="checkbox"/> 3/8" x 60 yd roll				
1399	<input checked="" type="checkbox"/> 1/2" x 60 yd roll				

DECOR ATG TAPES

2 mil permanent acrylic adhesive

*** * VOLUME PRICING * ***

Must order in 72 roll increments

Item	Description	72rl	144 rl	216 rl	288rl
364B**	1/2" x 36 yd roll				
366B	1/2" x 60 yd roll				

SCOTCH™ 969 HI-TAC ATG TAPE



3M

Permanent, heavy-duty strength you can rely on, in a 5 mil tape. Very-high initial adhesion makes it ideal for joining mat boards, for double mats along with bonding irregular surfaces.

1" Core 3M #969

No.	Description	Price Ea.	12 @	48 @	72 @
557 <input checked="" type="checkbox"/>	1/2" x 18 yd roll				
558 <input checked="" type="checkbox"/>	3/4" x 18 yd roll				
559 <input checked="" type="checkbox"/>	1/2" x 36 yd roll				
560 <input checked="" type="checkbox"/>	3/4" x 36 yd roll				

Can be used in Decor #320 ATG Gun or Decor #585 & #586 3M ATG Guns on pg 10.

SCOTCH™ Gold 908 Acid-Free ATG Tape



3M

The ideal acid-free transfer tape. It rolls on smooth and has quick initial tack. Great for all your framing, preservation and memorabilia applications. ATG Gold 908 by 3M Scotch has been ranked #1 in framing surveys. 3M #908

No.	Description	Price Ea.	12 @	48 @	72 @
700* <input checked="" type="checkbox"/>	1/4" x 36 yd roll				
701** <input checked="" type="checkbox"/>	1/2" x 36 yd roll				
702** <input checked="" type="checkbox"/>	3/4" x 36 yd roll				
703*** <input checked="" type="checkbox"/>	1/2" x 60 yd roll				
704*** <input checked="" type="checkbox"/>	3/4" x 60 yd roll				

* Can be used in Decor #585 or #586 w/adaptor kit.
 ** Can be used in Decor ATG Gun #320 or 3M Guns Decor #585 & #586
 *** Must be used in Decor gun #320 (pg. 10) or 3M Gun Decor #586.

3M 465 HAND HELD ATG TAPE



Tape that allows adhesive to transfer from liner to most smooth surfaces. Wound in Reverse. Liner is hand removable. Same adhesive as used in 924 tape. 2 mil thick.

3" Core 3M #465

Will not fit ATG Gun

Item	Description	Price Ea.	12@	48@	72@	96@
561 <input checked="" type="checkbox"/>	1/4" x 60 yard roll					
562 <input checked="" type="checkbox"/>	3/8" x 60 yard roll					
563 <input checked="" type="checkbox"/>	1/2" x 60 yard roll					
564 <input checked="" type="checkbox"/>	3/4" x 60 yard roll					

3M VHB TAPE

Created for hanging mismatched substrates



Perfect for hanging acrylic or glass art on metal or wood frames. Can be used for many interior and exterior permanent bonding applications. This is a multipurpose double-sided, pressure sensitive acrylic foam tape with a paper liner. This tape provides outstanding durability and excellent adhesion to mismatched substrates including metals, glass and a wide variety of plastics, wood, acrylic and plasticized vinyls. **To activate, use**

firm pressure such as a roller on both surfaces. Please follow application instructions and allow up to 24 hours to reach a 90% bond strength.

SAVE 10%

No.	Description	Price Ea.	3 +
598 <input checked="" type="checkbox"/>	1/2" x 36 yds (62 mil)		
599 <input checked="" type="checkbox"/>	3/4" x 36 yds (62 mil)		
1589 <input checked="" type="checkbox"/>	1" x 36 yds (62 mil)		

3" core. Hand applied.

U-GLU ADHESIVE TAPES

Perfect for mounting fabrics, jerseys and object framing



- Non-toxic and acid-free
- Conforms to uneven surfaces
- Instant grip - powerful bond
- Can be cleanly removed from most surfaces

A double-coated tape with an easy-to-remove release liner. Maximum holding weight is up to 2lbs. U-Glu should not be used on wallpaper or newly painted surfaces. Waterproof and weatherproof.

No.	Description	Price Ea.
1535 <input checked="" type="checkbox"/>	3/4" x 65 yds	
1536 <input checked="" type="checkbox"/>	1" x 65 yds	

3" core. Hand applied.

3M ATG 700 DISPENSER



Item	1 for	3 @
586 <input checked="" type="checkbox"/>	\$48.45 ea.	\$46.03 ea.

3M 1/4" ATG ADAPTOR KIT



3M This adapter kit when assembled to the Decor #586 3M 700 ATG dispenser allows the operator to dispense 1/4" ATG tape.

Item	1 for
587 <input checked="" type="checkbox"/>	\$20.54 ea.

DECOR EZ GLIDE ATG ADAPTOR

Helps guide the ATG Gun



Extended

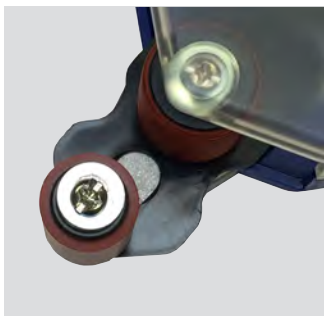

Retracted

Attaches to Decor ATG Gun #320 and 3M ATG 700 gun (Decor #586). Guides the gun along the moulding before applying backing paper to the frame. Made of nylon. Will not damage frames and helps apply ATG tape neatly and uniformly along the edge of the moulding. Snaps out of the way when using gun for other purposes.

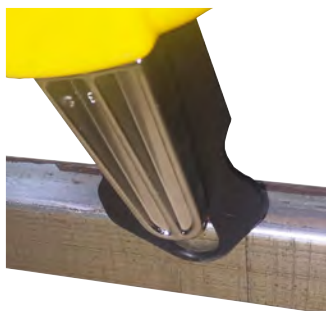

In use

Item	1 for
999 <input checked="" type="checkbox"/>	\$6.99 ea.

DECOR PREMIUM ATG DISPENSER



- Used with 1/2" & 3/4" ATG Tape
- Clear Cover
- Removes Liner

Decor's PREMIUM ATG Gun can be used with 1/2" and 3/4" on 18 yd., 36yd and 60yd ATG tape rolls. Features clear cover for easy visibility of tape and liner. Specially designed double roller system will not gum up with use. This lightweight applicator is ideal for high volume applications of neat, consistent strips of ATG Tape. Similar to 3M #700 ATG Gun at half the price.

Item	1 for
320 <input checked="" type="checkbox"/>	

DECOR ECONOMY ATG DISPENSER



Decor's ATG Gun features a Double Roller, Clear cover and can be used with 1/2" and 3/4" ATG Tapes in 18 or 36 yard rolls. Decor's own ATG tape dispenser has

a specially designed double roller system that will not gum up with use. Clear cover allows easy visibility of tape and liner. This lightweight applicator is ideal for high volume applications and will lay down a neat clean strip

Item	1 for
1516 <input checked="" type="checkbox"/>	

3M ATG 752C DISPENSER + 1/4" Conversion Kit



A blue adhesive tape gun for use with 1/4", 1/2" and 3/4" wide rolls. Holds up to 36 yard rolls.

Includes a tape conversion kit that allows the use of 1/4" wide rolls.

Item	1 for
585 <input checked="" type="checkbox"/>	

3M #810 MAGIC TRANSPARENT TAPES

Frosty appearance on the roll, yet invisible on most paper. Resists cracking and yellowing with age and can be written on. Designed for permanence for inlaid mats, paper mending, holding, and splicing.



#1483 1/2" x 1" core
#1484 3/4" x 1" core

#1485 3/4" x 3" core
#1486 1" x 3" core

Item #	Width	Length	Core	Price Each	12 rolls
1483 <input checked="" type="checkbox"/>	1/2"	36 yards	1"		
1484 <input checked="" type="checkbox"/>	3/4"	36 yards	1"		
1485 <input checked="" type="checkbox"/>	3/4"	72 yards	3"		
1486 <input checked="" type="checkbox"/>	1"	72 yards	3"		

These tapes use 3M Dispensers #592 or #593 on page 13.

3M #600 TRANSPARENT TAPES

Clear transparent tape with a wide range of uses. An economical general purpose transparent tape. Non-yellowing and easy to dispense. Ideal for general mending and holding.



#1487 3/4" x 1" core

#1488 3/4" x 3" core

Item #	Width	Length	Core	Price Each	12 rolls
1487 <input checked="" type="checkbox"/>	3/4"	36 yards	1"		
1488 <input checked="" type="checkbox"/>	3/4"	72 yards	3"		

These tapes use 3M Dispensers #592 or #593 on page 13.

GAFFERS TAPE - ACID FREE



Flexible fabric tape which is acid-free with strong adhesion to wood, paper and fabric. Great for lining shadowbox frames and mirror frames. Project construction canvas edges and more.

Item #	Price Ea.
1530 <input checked="" type="checkbox"/>	2" x 60 yards. 3" core

3M POSITIONABLE MOUNTING ADHESIVE

3M Positionable Mounting Adhesive (PMA) is the quick, clean alternative to spray adhesives for today's studio.



- Allows repositioning before bonding.
- Requires no heats, liquids, special equipment or clean-up.
- Ideal for desktop mounting in studio.
- Pressure activated adhesive for quick, clean and consistent bonding.
- Permanent bond will not stain or dry out
- Squeegee included.

Mix 'N Match for Quantity Prices

Item #	Size	Price Each	3 +
717 <input checked="" type="checkbox"/>	11" x 50 ft. PMA roll		
718 <input checked="" type="checkbox"/>	16" x 50 ft. PMA roll		
719 <input checked="" type="checkbox"/>	24" x 50 ft. PMA roll		

3M #811 REMOVABLE TAPES

A removable tape that comes off as easily as it goes on. Magic Plus is perfect for practically any use where you want to stick it down now without getting stuck for good.



#1480 1/2" x 1" core
#1481 3/4" x 3" core
#1482 1" x 3" core



#1482 1" x 3" core

Item #	Width	Length	Core	Price Each	12 rolls
1480 <input checked="" type="checkbox"/>	1/2"	36 yards	1"		
1481 <input checked="" type="checkbox"/>	3/4"	72 yards	3"		
1482 <input checked="" type="checkbox"/>	1"	72 yards	3"		

These tapes use 3M Dispensers #592 or #593 on page 13.

HIGHLAND™ INVISIBLE MENDING TAPE



A matte finish makes a great choice for inlaid mats, mending documents, drawing and other permanent type applications. Matte finish is invisible on most surfaces. Long aging and non-yellowing. Similar to 3M's #810.

3M 3M #6200

Item #	Width	Length	Core	Price Each	12 rolls
578 <input checked="" type="checkbox"/>	3/4"	36 yards	1"		
580 <input checked="" type="checkbox"/>	3/4"	72 yards	3"		

These tapes use 3M Dispensers #592 or #593 on page 13.

HIGHLAND™ TRANSPARENT TAPE



A clear transparent tape designed for light duty packaging applications and general office jobs. Similar to 3M's #600. 3M #5910

Item #	Width	Length	Core	Price Each	12 rolls
582 <input checked="" type="checkbox"/>	3/4"	36 yards	1"		
584 <input checked="" type="checkbox"/>	3/4"	72 yards	3"		

These tapes use 3M Dispensers #592 or #593 on page 13.

See back cover for details

Eff. 10/5/22

ACID FREE MASKING TAPE

A premium grade, high performance, all temperature adhesive tape with a crepe back.

No.	Width	Price Ea.	12 @
921 <input checked="" type="checkbox"/>	1/2"		
922 <input checked="" type="checkbox"/>	3/4"		
923 <input checked="" type="checkbox"/>	1"		
924 <input checked="" type="checkbox"/>	1-1/2"		
925 <input checked="" type="checkbox"/>	2"		



60 yard rolls / 3" Core

WHITE FLAT BACK TAPE

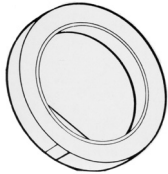

Highest Quality White Flatback tape used for sealing backs, splicing foamboard, reinforcing packaging and many more functions. 3" core. Easy tear, pressure sensitive.

No.	Description	Price Ea.	12 @	24 @
350 <input checked="" type="checkbox"/>	3/4" x 60 yd roll			
351 <input checked="" type="checkbox"/>	1" x 60 yd roll			
352 <input checked="" type="checkbox"/>	1-1/2" x 60 yd roll			
353 <input checked="" type="checkbox"/>	2" x 60 yd roll			

3M PRESSURE SENSITIVE FLAT BACK TAPE



Used in picture framing applications to seal back of frame/artwork due to its ability to stick to Kraft Paper and the back of wood Frames. For splicing liner boards, mat boards and other products for picture framing applications. 3"core. **3M #2517**

No.	Size	Price Each	24 +
363 <input checked="" type="checkbox"/>	2" x 60 yards		

BLACK FLAT BACK TAPE

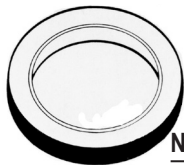

Highest Quality Black flat back tape used for sealing backs, splicing foamboard, reinforcing packaging and many more functions. 3" core. Easy tear, pressure sensitive.

No.	Description	Price Ea.	12 @
356 <input checked="" type="checkbox"/>	1" x 60 yd roll		
357 <input checked="" type="checkbox"/>	1-1/2" x 60 yd roll		
358 <input checked="" type="checkbox"/>	2" x 60 yd roll		

3M SCOTCH™ DOUBLE COATED FILM TAPE

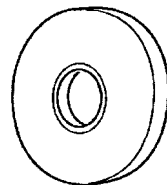

Used for mounting promotional items and archival encapsulation. Will not yellow or stain paper or degrade. **3M #415.**

No.	Description	Price Ea.	6 @
568 <input checked="" type="checkbox"/>	1/2" x 36 yd roll		

DECOR DOUBLE FACE VINYL TAPE



- Very tacky vinyl base adhesive
- Used to hold two surfaces together
- Used for heavy duty mounting
- Protective liner easily removed

No.	Description	Price Ea.	12 @
359 <input checked="" type="checkbox"/>	3/4" x 60 yd roll, 3" core		

3M SCOTCH #234 MASKING TAPE



This Scotch general purpose natural colored paper tape is designed for holding, bundling, sealing, painting and more. Works satisfactorily at 250°F for up to one hour. Sticks easily and tears easily. Uses Decor dispensers #592 or #593 (both pg 13). 3" Core. **3M #234**

Item #	Size	Price Each	12 +	24 +
721 <input checked="" type="checkbox"/>	3/4" x 60 yards			
722 <input checked="" type="checkbox"/>	1" x 60 yards			

DECOR ECONOMICAL MASKING TAPE

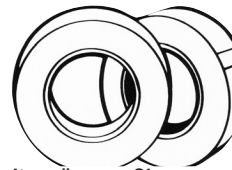

This extremely versatile crepe tape is economical and perfect for a variety of uses, including painting, bundling and sealing, etc. 3" Core.

Item #	Size	Price Each	12 +
340 <input checked="" type="checkbox"/>	1/2" x 60 yards		
341 <input checked="" type="checkbox"/>	3/4" x 60 yards		
342 <input checked="" type="checkbox"/>	1" x 60 yards		
343 <input checked="" type="checkbox"/>	1-1/2" x 60 yards		
344 <input checked="" type="checkbox"/>	2" x 60 yards		

SAVE 10%

3M 201+ MASKING TAPE



This economy natural colored pressure sensitive crepe paper tape can be used for holding, bundling, sealing and miscellaneous uses. No adhesion residue. 3" core. **3M #201+**

Item #	Size	Price Each	12 +	24 +
569 <input checked="" type="checkbox"/>	1/2" x 60 yards			
570 <input checked="" type="checkbox"/>	3/4" x 60 yards			
571 <input checked="" type="checkbox"/>	1" x 60 yards			
572 <input checked="" type="checkbox"/>	1-1/2" x 60 yards			
573 <input checked="" type="checkbox"/>	2" x 60 yards			

SAVE 10% SAVE 15%

BLACK-CREPE MASKING TAPE



Premium Quality
3" core
Dull Matte Black Color

Item #	Size	Price Each	12 +
346 <input checked="" type="checkbox"/>	3/4" x 60 yards		
347 <input checked="" type="checkbox"/>	1" x 60 yards		
348 <input checked="" type="checkbox"/>	2" x 60 yards		

INVISIBLE CLEAR TAPE / Crystal Clear

Comparable to J-Lar, yet 38 more yards per roll at a fraction of the cost.

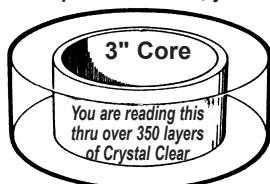

Clear is much better than masking tape for inlaid mats. It's also ideal tape for mending all kinds of paper items - book pages, art prints, maps, etc. Use for matting work and general purpose business office applications. Does not yellow, discolor or dry out.

Item #	Size	Price Each	SAVE 10% 6 +
336 <input checked="" type="checkbox"/>	3/4" x 110 yds.		
337 <input checked="" type="checkbox"/>	1" x 110 yds.		

DECOR BOX SEALING / PACKING TAPE

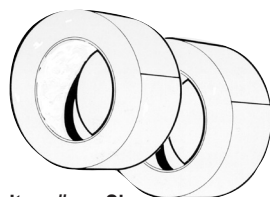

High Performance - Clear
First Quality - 2" and 3" wide. Made for sealing and packing cartons and boxes. Meets U.S. Postal requirements. 3" Core. #360 and #361 use dispenser #639 (below). #355 uses dispenser #644 (below).

Item #	Size	Price Each	12 +	36 +
360 <input checked="" type="checkbox"/>	2" x 55 yards			
361 <input checked="" type="checkbox"/>	2" x 110 yards			
355 <input checked="" type="checkbox"/>	3" x 110 yards			

3M BOX SEALING / PACKING TAPE



An industrial packaging tape used for box sealing and other packaging applications. Meets US Postal Regulations. Clear. 1.9 mm. 3" Core. **3M #371**

Item #	Size	Price Each	12 +	36 +
590 <input checked="" type="checkbox"/>	2" x 60 yards			
591 <input checked="" type="checkbox"/>	2" x 110 yards			

BOX SEALING / PACKING TAPE DISPENSERS



Dispensers have semi-automatic shut-off that will allow you to seal cartons and boxes with a minimum amount of effort. ONE HAND operation will attach a strip of PVC tape. You determine cut-off point with a flick of the wrist. Built-in cutoff bar cuts tape quickly and cleanly. Both units hold up to 110 yard rolls.

Item #	Description	Price Each
639 <input checked="" type="checkbox"/>	Holds up to 2" wide x 110 yds on 3" core	
644 <input checked="" type="checkbox"/>	Holds 3" wide x 110 yds on 3" core	

3/4" FILAMENT (STRAPPING) TAPE

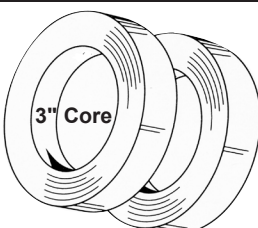

Glass-reinforced acetate backed tape. For use in strapping packages, bundles, mouldings, etc. **VERY STRONG**. Will not cut by hand! Meets U.S. Postal Regulations.

Item #	Size	Price Each	12+	SAVE 10%
362 <input checked="" type="checkbox"/>	3/4" x 60 yds.			

J-LAR CRYSTAL CLEAR TAPE



Glossy, brilliantly clear to the core. Used for over-lamination, label protection, light closure paper repair/mending and holding applications. Will not yellow with age, nor discolor packages or objects after being applied. Lightweight, yet strong. Ideal for use with desktop dispenser units. Stronger than cellophane or acetate. Hand tear-

Item #	Size	Price Each	6 +
1531 <input checked="" type="checkbox"/>	1/2" x 72 yd.roll		
1532 <input checked="" type="checkbox"/>	3/4" x 72 yd. roll		
1533 <input checked="" type="checkbox"/>	1" x 72 yd. roll		

SCOTCH™ WHITE PAPER TAPE

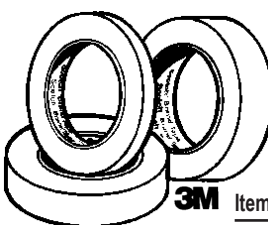

This printable paper tape is coated with a medium tack adhesive that allows for clean removal from most surfaces, even after prolonged periods of application. Uses include hinging and flapping artwork. Crepe texture, soft white, gloss finish.

Item #	Size	Price Each
3M #256		
575 <input checked="" type="checkbox"/>	3/4" x 60 yd.roll	
576 <input checked="" type="checkbox"/>	1" x 60 yd. roll	

DECOR WRITABLE WHITE ARTIST TAPE

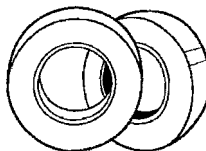

Premium flatback matte white paper tape used for labeling. Prints with pens, markers, pencils and flexo inks. Protects the edges of deep bevels on foamboards and mats. Removes cleanly and safely from boards. No stain or residue after removal. Easily repositions. pH neutral.

Item #	Size	Price Each	12 +	SAVE 10%
393 <input checked="" type="checkbox"/>	1/2" x 60 yd. roll			
394 <input checked="" type="checkbox"/>	3/4" x 60 yd. roll			
380 <input checked="" type="checkbox"/>	1" x 60 yd. roll			

PRESSURE SENSITIVE KRAFT PAPER TAPE



This tape, made of kraft paper is perfect for sealing the back of pictures. Easy to use, premium quality.

Item #	Size	Price Each	24 +	SAVE 10%
374 <input checked="" type="checkbox"/>	1 1/2" x 60 yds			
375 <input checked="" type="checkbox"/>	2" x 60 yds			
376 <input checked="" type="checkbox"/>	3" x 60 yds			

SCOTCH™ MAINLINE TAPE DISPENSER

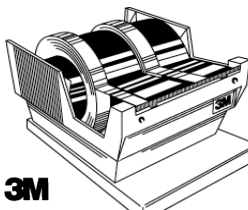

A versatile way to dispense several rolls of tape in one place. Weighted dispenser holds one or more rolls of tape in a variety of widths up to a total of 6 rolls on 3" cores. **3M #P56W**

Item #	Price Each
592	

HIGHLAND™ TABLETOP WEIGHTED TAPE DISPENSER

Economical, weighted plastic shell tape dispenser for heavy duty use. Unique dual mandrel accepts tape up to 1" wide on a 1" or 3" diameter core. **3M #HB-900**

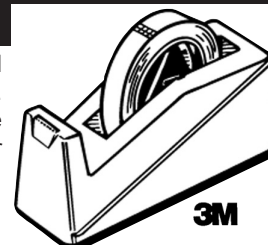

Item #	Price Each
593	

See back cover for details

Eff. 3/28/23

ART CONSERVATION PRODUCTS

ARCHIVAL CLEAR MOUNTING CORNERS by 3L

3L corners are made from 100% acid free, archival safe polypropylene for extra strength. Contains no harmful materials and the corners are totally environmentally friendly. Corners have a permanent acrylic adhesive that will never come in contact with the art when used correctly. Corners meets all archival and conservation requirements for assured preservation standards and archival use. Ideal for photographers, museums, libraries and other archival uses. Corners are transparent and the strong high quality polypropylene provides an unobstructed view of the mounted image and will not bleed or crawl.

Actual size

MIX 'N MATCH for QUANTITY PRICES

Item #	Description	View	Qty/Pkg.	Reg.	5+ Pkg
01729	19mm-3/4"x3/4"	Regular	250		
01730	32mm-1 1/4"x1 1/4"	Regular	250		
01731	32mm-1 1/4"x1 1/4"	Maxi	250		
01732	75mm-3"x3"	Regular	100		
01733	75mm-3"x3"	Maxi	100		

LINECO SEE-THRU MOUNTING STRIPS

Made of conservation quality materials. Clear polyester is bonded to a 2-ply mat with a self-adhesive backing. No adhesive touches the art. Trims easily to desired size and to accommodate matboards and moulding.



Item #	Size	Quantity	Price Each
L5334015	4" strips	60 per box	
L5334020	12" strips	60 per box	

LINECO ACID-FREE SELF-ADHESIVE PHOTO CORNERS

Don't let inferior corners damage your important photographic memories



L5330024PS



L5330025PS

Our Archival Photo Corners are .5" and made from acid-free paper with safe adhesives that won't harm delicate photographic emulsions. Available in black and ivory. Price per package of 252 corners.

Item #	Color	Price
L5330024PS	Black	
L5330025PS	Ivory	

LINECO MYLAR MOUNTING CORNERS

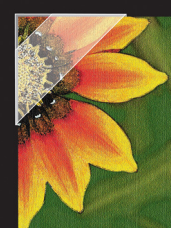

A self-adhesive archival polyester corner to secure artwork for framing. Crystal clear with non-yellowing acrylic adhesive backing that does not yellow or dry out.



Item #	Size	Quantity	Price Each
L5330020	1/2"	240 per box	
L5330021	1 3/8"	240 per box	

LINECO FULL-VIEW ARCHIVAL CORNERS

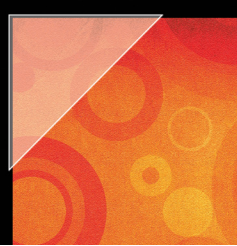

A self-adhesive acid-free clear polypropylene corner to secure artwork for framing. Artwork never contacts the adhesive. Full-view style reduces the border needed to cover the corner under the window mat.



Item #	Size	Quantity	Price Each
L5330022	5/8"	500 per box	
L5330034	1 1/4"	250 per box	
L5330035	1 1/4" Full View	250 per box	
L5330036	3"	100 per box	
L5330037	3" Full View	100 per box	

FRAMER'S STITCHERY TAPE

Safely mount fabric or needlework to artboard, foam core or stretcher bars. The ultimate double-sided pH neutral "archival grade" adhesive tape will adhere fabrics as delicate as silk, linen or velvet without adhesive bleed through or damage to fabric. This tape eliminates glue, pins and staples. **SAVE 10%**

Item #	Size	Price Each	12 @
379	1-1/2" x 54 yds.		

FRAMER'S TAPE II



- Removable with minimal heat
- Thick and strong, yet easy to handle for every hinging need
- pH neutral - won't yellow
- Acid free pressure sensitive

• Professional hinging tape • Archival grade **SAVE 15%**

Item #	Color	Size	Price Each	12 @
377	White	3/4" x 180 feet		
378	White	1" x 180 feet		
1567	Clear	3/4" x 180 feet		
1568	Clear	1" x 180 feet		

ACID-FREE FRAMERS TAPE



A pressure-sensitive polyethylene cloth tape developed specifically for acid-free mounting, matting and framing of artwork and prints.

- Acid-free, leaves no stains on prints or mats and will not deteriorate on artwork.
- Easy-to-use, no mess, simply unwind & apply, hand tearable.
- Excellent adhesion.

SAVE 6% SAVE 10%

Item #	Size	Price	6 +	12+
761	1" x 20 yds.			
762	1" x 60 yds.			

DECOR ACID-FREE GUMMED LINEN TAPE

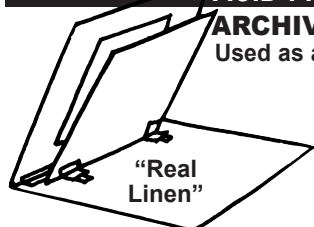

ARCHIVAL QUALITY LINEN TAPE
Used as a cloth hinge for double matting.

- 100% Linen, not holland shade cloth like others sell. Water activated.
- Tape is acid-free so it can be used on valuable documents, prints, etc. as well as for double matting.
- Extra strong gummed adhesive won't yellow or flake when bent.

Item #	Description	Price Each
953 <input checked="" type="checkbox"/>	1" wide x 150 ft. roll	
391 <input checked="" type="checkbox"/>	1" wide x 300 ft. roll	

LINECO GUMMED LINEN HINGING TAPE for HEAVY ART



Water activated & reversible acid-free fabric gives great strength for heavy watercolors or collages. High tack neutral pH adhesive works quickly. Use for originals and limited editions.



Item #	Size	Price Each
L5331025 <input checked="" type="checkbox"/>	1" x 30 ft.	
L5331050 <input checked="" type="checkbox"/>	1" x 150 ft.	
L5331010 <input checked="" type="checkbox"/>	1" x 300 ft.	

DECOR ACID-FREE SELF-ADHESIVE LINEN TAPE

White linen tape with permanent adhesive. Can be used to reinforce folders or book covers. Excellent for hinging window mats to backing board. pH neutral with non-yellowing adhesives. Safe on paper.



Item #	Description	Price Each
1551 <input checked="" type="checkbox"/>	1 1/4" wide x 150 ft. roll	

LINECO SELF-ADHESIVE LINEN CLOTH TAPE



Very fine white linen cloth hinges window mats to backboard or attaches art. Flexible, but strong. Neutral pH acrylic adhesive gets stronger overnight.



Item #	Size	Price Each
L5331055 <input checked="" type="checkbox"/>	1 1/4" x 150 ft.	

LINECO GUMMED PAPER HINGING TAPE

Acid-free, lignin-free, buffered water activated and reversible paper tape designed for general hinging. Neutral pH adhesive tape is the first choice for most valued art.



Item #	Size	Price Each
L5330751 <input checked="" type="checkbox"/>	1" x 130 ft.	

LINECO Abaca.sa PAPER HINGING TAPE

for Digital Giclee Inkjet prints
Strong enough to hold large giclee inkjet prints and supple enough to adhere to the print without distorting. Acid-free, biodegradable, non-yellowing and permanent acrylic adhesive.



Item #	Size	Price Each
L5330754 <input checked="" type="checkbox"/>	7/8" x 150 ft.	

LINECO SELF-ADHESIVE HINGING & MOUNTING TISSUE



Mount or hinge thin papers easily and without worry. Tissue virtually disappears after it is applied to the art. Neutral pH acrylic adhesive will not turn yellow with age.



Item #	Size	Price Each
L5330125 <input checked="" type="checkbox"/>	1" x 35 ft.	
L5330126 <input checked="" type="checkbox"/>	1" x 98 ft.	

LINECO MUSEUM MOUNTING KIT



Everything you need to mount graphics and original art using rice starch and paper hinges. This kit contains a 2 oz. jar of unmodified Wheat Starch Adhesive, enough heavyweight Mulberry Paper to make approximately 150 hinges, a 1" x 10" roll of pressure sensitive linen tape for hinging mats, a blotter and a polyester sheet. Complete instructions included.

Item #	Price Each
L5332000 <input checked="" type="checkbox"/>	

LINECO pH NEUTRAL TRANSPARENT MENDING TISSUE

Neutral pH, non-yellowing, very thin and extremely transparent pressure-sensitive archival mending tissue repairs tears quickly and easily with a burnishing bone.

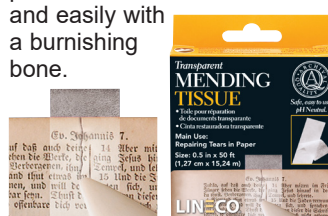

Item #	Size	Price Each
#L5330017		#L9010198

L5330017 <input checked="" type="checkbox"/>
L9010198 <input checked="" type="checkbox"/>

LINECO BUFFERED ACID-FREE TISSUE

This .001 thick acid-free tissue has a 3% calcium carbonate buffer added. Buffering agent will help prevent acid migration to the tissue itself.



Item #	Size	Pack	Price
L7412504BF <input checked="" type="checkbox"/>	40" x 250' roll	1 roll	

LINECO HAYAKU GUMMED JAPANESE HINGING PAPER



A Japanese Mulberry paper coated with acid-free water activated adhesive. Use for originals and limited editions. Extremely strong, long-fibered hinging material. Water reversible.

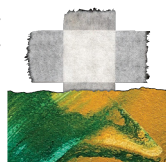

Item #	Size	Price Each
L5330752 <input checked="" type="checkbox"/>	1" x 100 ft.	

LINECO MULBERRY HINGING PAPER

This high quality, strong, japanese paper is ideal for making conservation hinges. Convenient tear-off roll with feathered edge. For use with wheat/rice starch or methyl cellulose homemade paste. Easily makes T-hinge or V-hinge, corners or slings.



Item #	Size	1 roll	2+ rolls
L5330756	1" x 100 ft		

SAVE 10%

ART CONSERVATION PRODUCTS

FILMOPLAST P - Transparent Repair Tape



Used in libraries and archives for mending torn artwork, documents, etc. Also well-suited for hinging artworks done in thin lightweight papers. The exceptionally thin paper carrier will not show through and since it is self-adhesive there is no danger of damaging the paper with excess water. The adhesive used will not dry out, stain or become brittle with age.

- **Acid Free**
- Packaged in handy dispenser
- Once burnished the tape becomes transparent

Item #	Size	Price Each	3 +	12+
382 <input checked="" type="checkbox"/>	3/4" x 165 ft.			

FILMOPLAST P90 - Framer's Tape



A self-adhesive paper hinging tape used extensively as a safe and easy means of hinging artworks that do not demand wheat past hinges. Coated with acid and solvent-free water borne acrylic adhesive, "P-90" will not dry out, stain or discolor with age. The tape is buffered with calcium carbonate giving it a slightly alkaline pH level that will neutralize any acids that come in contact. Available in two widths to hold even large pieces of art securely. "P-90" is compatible

with all quality mat and backing boards. Easy to use disposable dispenser.

- Water based ACID FREE
- No wetting required

SAVE in LARGER QUANTITIES

Item #	Size	Price Each	3 +	12+
383 <input checked="" type="checkbox"/>	3/4" x 165 ft.			
384 <input checked="" type="checkbox"/>	1 1/2" x 165 ft.			

FILMOPLAST P90 Plus-Framer's Tape PLUS



Specifically designed for fine art hinging. The adhesive used is a refined version of the original that provides better initial and final bond strength - all while retaining the same stable aging characteristics of the original P90. Coated with **acid and solvent-free** water borne acrylic adhesive, Filmoplast P-90 Plus will not dry out, stain or discolor with age. The tape is buffered with calcium carbonate giving it a slightly alkaline

pH level that will neutralize any acids that come in contact.

- Water based **ACID FREE**
- No wetting required

Item #	Size	Price Each	3 +	12+
386 <input checked="" type="checkbox"/>	3/4" x 165 ft.			

FILMOPLAST SH Self Adhesive White Linen Tape



Used for applications that demand exceptional strength. The fine threaded natural linen fabric folds flat and is coated with a high tack **acid and solvent-free** acrylic adhesive. Ready to use with no wetting required.

Filmoplast SH is ideal for hinging quality window mats to backing boards.

Item #	Size	Price Each	3 +	12+
385 <input checked="" type="checkbox"/>	1.2" x 82 ft.			

LINECO FOIL RABBET & FRAME SEALING TAPE

Developed specifically to seal backing board to frames, this pressure sensitive tape attaches firmly to almost any surface and conforms well to most surface irregularities. Made from Lineco's exclusive Perma/Seal label stock with a foil layer, a non-yellowing, permanent acrylic adhesive and coated to match Frame Backing Paper #L6130035. Also provides an effective barrier for the rabbets of wooden frames.

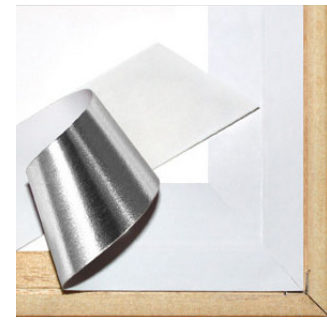

Item #	Size	Color	Price
L3870151 <input checked="" type="checkbox"/>	1 1/4" x 85 ft.	Gray	
L3870152 <input checked="" type="checkbox"/>	1 1/4" x 85 ft.	White	
L3870155 <input checked="" type="checkbox"/>	1 1/4" x 500 ft.	Gray	
L3870156 <input checked="" type="checkbox"/>	3 1/2" x 85 ft.	Gray	

LINECO VOLARA RABBET SEALING TAPE



This inert, .0313" thick foam tape features an aggressive acrylic adhesive for lining frame rabbets. Protects canvas transfers, digital media and other forms of art by providing a cushion.

Item #	Price
L0181436 <input checked="" type="checkbox"/>	1/4" wide x 36yds

LINECO i-FILM

Helps retard acids, corrosive gases, and resists mold and mildew. Strong adhesive sticks to raw wood. It is flexible, strong and puncture resistant for easy application. Passed the PAT test. Features "Corrosion Intercept", a polyethylene embedded with a copper matrix which is coated with an acrylic adhesive. 1-1/4" wide x 1000"



Item #	Price
L0342000 <input checked="" type="checkbox"/>	

LINECO TYVEK TAPE



Pressure sensitive white polyesthylene Tyvek tapes. Used for hinging mats, binding folder spines, performing book repairs to battered books as well as a variety of other uses. Eliminates the sticky mess associated with moistenable adhesive backed Tyvek tapes around valuable artwork.

Item #	Size	Price Ea.
L8040150 <input checked="" type="checkbox"/>	1" x 85 yds	
L8041550 <input checked="" type="checkbox"/>	1 1/2" x 50 yds	
L8042250 <input checked="" type="checkbox"/>	2 1/4" x 85 yds	

LINECO METHYL CELLULOSE Adhesive

A neutral pH adhesive that is great for long term stability. Excellent for use in repairs, bookbinding, art construction, hinging and general archival adhesive applications. Dries clear. Reversible with cold water.

- Neutral pH
 - Non-toxic
 - Clear-drying
 - Vermin-proof
- | Item # | Size | 1 bottle |
|-----------------|--------|----------|
| L7931001 | 1.5 oz | |



LINECO PURE WHEAT STARCH ADHESIVE

Mount museum quality works with pure wheat starch adhesive. pH neutral and requires cooking. A very carefully purified, uncooked food-grade wheat starch. When cooked, it makes a superior smooth wheat paste adhesive.

- SAVE 10%**
- | Item # | Size | 1 bottle | 2+ bottles |
|-----------------|------|----------|------------|
| L6151002 | 2 oz | | |



LINECO PURE RICE STARCH ADHESIVE

Mount museum quality works with pure rice starch adhesive. pH neutral and requires cooking. Similar to wheat starch, but it yields a lighter, thinner starch adhesive paste after cooking.

- SAVE 10%**
- | Item # | Size | 1 bottle | 2+ bottles |
|-----------------|------|----------|------------|
| L6151502 | 2 oz | | |



KLUCEL G CELLULOSE ADHESIVE

Can be dissolved in either water or alcohol. In alcohol its solubility presents the most useful possibility. It introduces the prospect of adhesion without the deformation that water can cause. Also a leather consolidant that assists in the prevention of the spread of damage caused by red rot.



- Won't be metabolized by molds or pests
- No refrigeration necessary
- Extensive hand drying with desiccated blotters is no longer critical
- Allows the creation of hinges nearly as wide as the artwork itself

Item #	Size	Price Each
L6155582G <input checked="" type="checkbox"/>	2 oz.	

GATORFOAM®

Lightweight rigid display board for printing and laminating. Firm and dense polystyrene core with resin impregnated wood fiber surfaces on both sides that is water resistant.

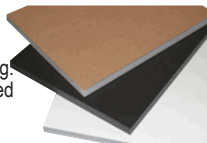

SAVE 15% SAVE 20%

Item #	Size	Color	Core	Shts/Bx	1 Sheet	1 Boxes	3 Boxes
265	3/16" - 48" x 96"	White	White	15			
266	3/16" - 48" x 96"	Black	Black	15			
267	3/16" - 48" x 96"	Natural	White	15			
268	1/2" - 48" x 96"	White	White	12			

LINECO Gray FRAME BACKER PAPER

This backer paper will add value and differentiate the quality of framed artwork. Acid-free and buffered with 3% calcium carbonate to protect the artwork. Moderate porosity allows the frame package to breath and the standard weight paper cuts cleanly and is easily handled. 40lb. paper. Passed PAT.



Item #	Size	1 roll	3+ rolls
L6130035	36" x 300 ft		

SAVE 10%

LINECO PAPER & BOARD pH TESTING PEN



Easily determine whether the paper and board you are using is acidic. Easy-to-use, simply draw a small line on the material you wish to test. The chlorophenol red indicator solution in the pen will turn purple on any paper with a pH of 6.8 and above. A clear or yellow color indicates the material is probably unsuitable for conservation purposes. Please note: unreliable results may occur on colored or coated papers

Item #	Price
L5330023 <input checked="" type="checkbox"/>	

LINECO WHITE NEUTRAL pH ADHESIVE



Used for collages, adhering mats, objects within a frame and bookbinding. Will not brittle with age. Excellent lay properties, good open time and is quick setting. Not recommended for hinging art. Remoistens with water.

Item #	Size	Price Each
L9011008 <input checked="" type="checkbox"/>	8 oz.	

DEACIDIFICATION SPRAY



Bookkeeper Spray Products safely treats manuscripts, documents, clippings, maps, posters, and other paper-based materials contained in modern library and archival collections.

The suspension dries odor free in minutes and does not damage inks, adhesives, or binding materials. It is non-clogging, non-toxic, non-hazardous, non-flammable, does not contain CFC's and is completely safe for the environment.

It deposits a safe, non-toxic alkaline buffer into the structure of the paper. This buffer material neutralizes acids that can rapidly weaken the paper and cause it to become brittle. Does not expire.

Item #	Size	Price
1336 <input checked="" type="checkbox"/>	5.3 oz pump	
1337	32 oz refill	

DECOR COROPLAST Archival Fluted Polypropylene Sheets



Coroplast's 3/16" (4mm) fluted polypropylene acid-free sheets are neutral pH, lightweight, waterproof corrugated plastic that can be used for backing in frames, archival packaging, boxes and advertising signage. Color: white

Item #	Size	1-14 sheets	15 shts
280	40 x 60		
281	48 x 96		

See back cover for details

Eff. 3/8/23

FRAMESPACE®

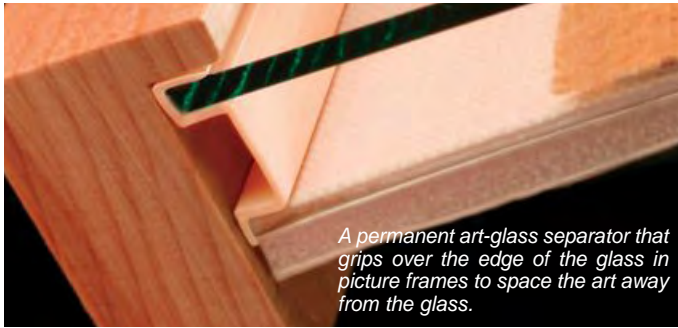

A permanent art-glass separator that grips over the edge of the glass in picture frames to space the art away from the glass.

FrameSpace® is made from a neutral pH plastic. It helps prevent mold growth, paper buckling, image transfer and adhesion to the glass. Removes easily to clean or replace the glass. The deeper shapes can be used to make any appropriate wood or metal frame into a shadowbox for framing objects.

- Quick-and-easy. Saves time
- Works in any frame.
- Professional looking - No painting.
- Works in both wood & metal frames.
- Neutral pH - No plasticizers - Won't harm art.
- Permanent - No glues or adhesives required.
- Protects glass from chipping in metal frames.

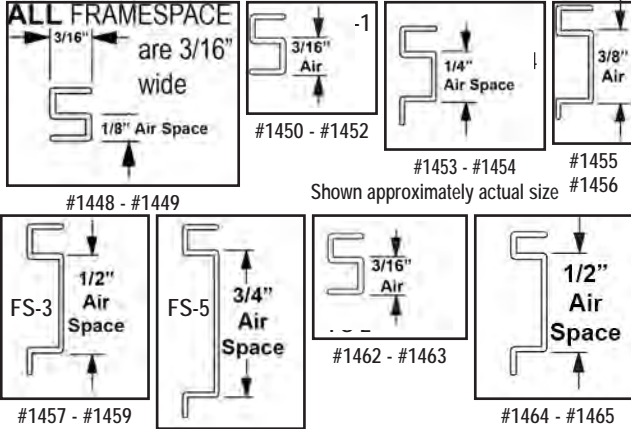

FrameSpace® MIX 'N MATCH FrameSpacers
ship UPS for Quantity Discounts

Item #	Frame-Space #	Air Space	Color	Bundle Desc.	Glass/Acrylic Thickness	1 Bundle	5 Bundles
1448	FS-6	1/8"	Clear	20 x 5' sticks	2mm/2.5mm		SAVE
1449	FS-6	1/8"	Black	20 x 5' sticks	2mm/2.5mm		
1450	FS-1	3/16"	Clear	20 x 5' sticks	2.5mm/ 1/8"		
1451	FS-1	3/16"	Black	20 x 5' sticks	2.5mm/ 1/8"		
1452	FS-1	3/16"	White	20 x 5' sticks	2.5mm/ 1/8"		
1453	FS-4	1/4"	Clear	12 x 5' sticks	2.5mm		
1454	FS-4	1/4"	Black	12 x 5' sticks	2.5mm		
1455	FS-9	3/8"	Clear	12 x 5' sticks	2.5mm		
1456	FS-9	3/8"	Black	12 x 5' sticks	2.5mm		
1457	FS-3	1/2"	Clear	12 x 5' sticks	2.5mm		
1458	FS-3	1/2"	Black	12 x 5' sticks	2.5mm		
1459	FS-3	1/2"	White	12 x 5' sticks	2.5mm		
1460	FS-5	3/4"	Clear	12 x 5' sticks	2.5mm		
1461	FS-5	3/4"	Black	12 x 5' sticks	2.5mm		
1462	FS-2	3/16"	Clear	20 x 5' sticks	2mm		
1463	FS-2	3/16"	Black	20 x 5' sticks	2mm		
1464	FS-3	1/2"	Clear	12 x 5' sticks	2mm		
1465	FS-3	1/2"	Black	12 x 5' sticks	2mm		

ECONOSPACE®

"Peel-and-Stick"

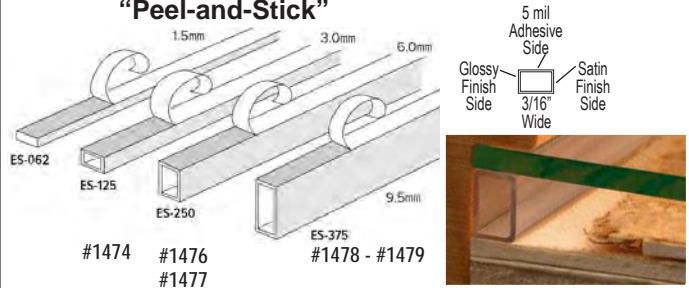

EconoSpace® is a neutral pH plastic "peel & stick" type art-glass separator that bonds to the edge of the glass. This makes the proper airspace between the art and glass in either wood or metal frames. Helps prevent mold growth, paper buckling, image transfer and adhesion to the glass. Quick & easy. Cuts easily & clean with razor or shears. Professional looking - No painting. Neutral pH - No plasticizers - Won't harm fine art.

EconoSpace® MIX 'N MATCH Econospacers
ship UPS for Quantity Discounts

Item #	Frame Space #	Air Space	Color	Type	Bundle Desc.	1 Bundle	3 Bundles
1470	ES-062	1/16"	Clear	Solid	20 x 5' sticks		SAVE
1471	ES-062	1/16"	Black	Solid	20 x 5' sticks		
1472	ES-125	1/8"	Clear	Hollow	20 x 5' sticks		
1473	ES-125	1/8"	Black	Hollow	20 x 5' sticks		
1474	ES-125	1/8"	White	Hollow	20 x 5' sticks		
1475	ES-250	1/4"	Clear	Hollow	12 x 5' sticks		
1476	ES-250	1/4"	Black	Hollow	12 x 5' sticks		
1477	ES-250	1/4"	White	Hollow	12 x 5' sticks		
1478	ES-375	3/8"	Clear	Hollow	12 x 5' sticks		
1479	ES-375	3/8"	Black	Hollow	12 x 5' sticks		

Econospace™ can be stacked to achieve the space you require.

RABBETSPACE®

Rabbit Depth Extender Strips

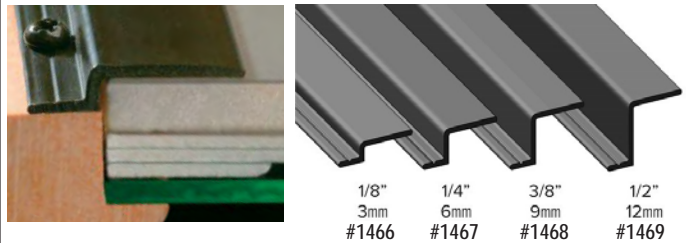

RabetSpace® is a black satin finish neutral pH plastic rabbet depth extender used on the back of wood picture frames to extend the depth of shallow rabbets. Easy-to-use. Looks professional. Mitre RabetSpace to fit the back of the frame. Drill pilot and clearance holes at the same time. Attach to the back of the frame using the included black plated #2 x 1/4" round head Phillips screws.

RabetSpace® MIX 'N MATCH RabetSpacers
ship UPS for Quantity Discounts

Item	Extension Size	Bundle Desc.	1 bundle	3 bundles
1466	1/8" (3mm)	7 x 5' sticks		
1467	1/4" (6mm)	7 x 5' sticks		
1468	3/8" (9mm)	7 x 5' sticks		
1469	1/2" (12mm)	7 x 5' sticks		



WIZARD MITER HAND CUTTER

Specifically designed tool to cut mitres on wood and poly fillets, Decor Archival Glass & Art Spacers (opp. pg.), FrameTek products (above) and plastic channels (pg 38). Great on balsa strips (opp. pg). Cuts mitered angles from 45° to 120°. Built-in safety lock. No-slip rubber grips. Carbon steel blade.

Item	Description	Price
1489	Wizard Miter Hand Cutter	
1490	Replacement Blade	

SOLID SPACERS

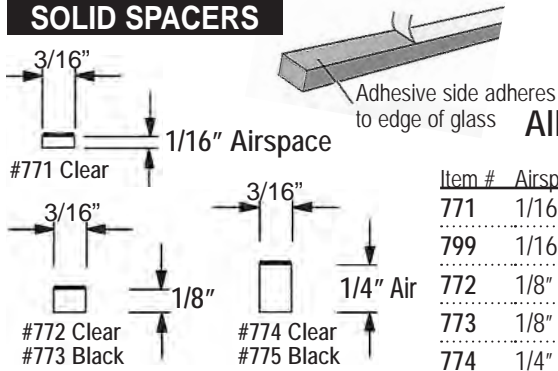

MIX 'N MATCH SPACERS for Quantity Discounts

All DECOR Spacers™ ship UPS

SAVE 5% SAVE 10% SAVE 35%

HOLLOW SPACERS

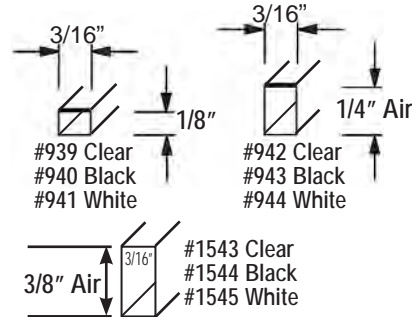

Item #	Airspace	Color	Type	Bundle Desc.	Length	1 Bundle	2 Bundles	4 Bundles	10 Bundles
771	1/16"	Clear	Solid	20 x 5' sticks	100'				
799	1/16"	Black	Solid	20 x 5' sticks	100'				
772	1/8"	Clear	Solid	20 x 5' sticks	100'				
773	1/8"	Black	Solid	20 x 5' sticks	100'				
774	1/4"	Clear	Solid	12 x 5' sticks	60'				
775	1/4"	Black	Solid	12 x 5' sticks	60'				
939	1/8"	Clear	Hollow	20 x 5' sticks	100'				
940	1/8"	Black	Hollow	20 x 5' sticks	100'				
941	1/8"	White	Hollow	20 x 5' sticks	100'				
942	1/4"	Clear	Hollow	12 x 5' sticks	60'				
943	1/4"	Black	Hollow	12 x 5' sticks	60'				
944	1/4"	White	Hollow	12 x 5' sticks	60'				
1543	3/8"	Clear	Hollow	12 x 5' sticks	60'				
1544	3/8"	Black	Hollow	12 x 5' sticks	60'				
1545	3/8"	White	Hollow	12 x 5' sticks	60'				

Specifications: pH Neutral peel-'n-stick spacers. Available in clear, black and white (all sides uniformly finished to avoid mismatched sides). Cuts easily using common shop tools such as cutting sheers, fillet trimmers and foot choppers. Easy and quick to install for metal or wood frames with glass or plexi. Aggressive double-sided tape adhesive for secure bonding.

Uses: DECOR Archival Glass & Art Spacers™ are ideal for a variety of professional picture framing applications.

- All archival applications involving glazing should incorporate Archival Glass & Art Spacers™ to keep the artwork or print away from the glass or acrylic to avoid image transfer and

condensation damage.

- Photographs are particularly susceptible to humidity damage resulting from contact with glazing surfaces.
- Pencil, pastels, charcoals and even a child's crayon masterpiece should not contact a glazing surface as all dry mediums are very subject to image transfer.
- Textured mats, fillets, fabric wraps, needlework and float mounting would be flattened or distorted if not separated from the glass.
- Can be stacked to achieve the space you require.

PRESSURE SENSITIVE ADHESIVE HANGERS

Slot hang tabs are ideal for both single- and double-wire peg hooks. Slot hang tabs allow you to display your product vertically, face-forward, anywhere in the store. Display more in less space. Your products will self-center and load easily.

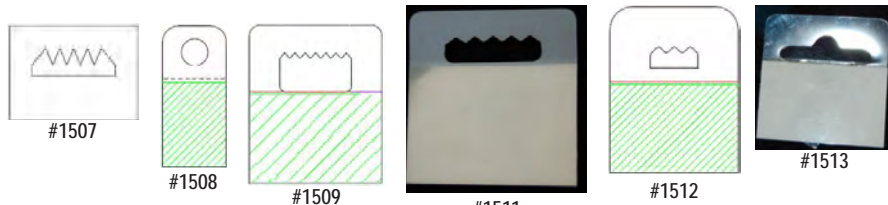

Item	Size / Description	Not shown actual size	
		100/pkg 1 Pkg.	1,000/pkg 1 Pkg.
1507	1-1/16HX 1-7/16W Sawtooth: Staple or Glue on		1507T
1508	1-21/32H X 3/4W Circle: Pressure Sensitive		1508T
1509	1-25/32H X 1-1/2W Sawtooth: Pressure Sensitive		1509T
1510	2-7/8HX 1-7/16W Sawtooth: Pressure Sensitive		1510T \$101.99
1511	2-1/32H X 2W Sawtooth: Pressure Sensitive		1511T
1512	1-7/8H X 1-7/16W Sawtooth: Pressure Sensitive		1512T
1513	1-21/32HX 1-5/8W Oblong Hole: Pressure Sensitive		1513T
1514	1-21/32HX 1-5/8W Oblong Triangle Top: Pressure Sensitive	\$8.39	1514T



BALSA WOOD SPACERS



Natural light weight wood strips made of balsa. Used for spacing between glass and mat board. Can be painted or stained. Set with pins or glue. Available in 36" lengths. Ships UPS. Packed in bundles of 25 sticks.

Item	Size	Price	4 bundles
1400	1/8" x 1/8"		
1401	1/8" x 3/16"		
1402	1/4" x 1/4"		

See back cover for details Eff. 7/1/22

PLASTIC BAGS on ROLLS

- High Clarity
- High Shine
- Virgin Plastic
- Protect artwork prior to framing
- Protect customer pick-ups
- Store artwork
- Cover framed pieces to be transported



Item # Size Bags/Roll **SAVE** 5% 10%

MIX 'N MATCH ALL "P" STYLES FOR QUANTITY PRICING

P1417	14" X 17"	500	1 +	5 +	10 +
P1821	18" X 21"	350			
P2125	21" X 25"	250			
P2535	25" X 35"	150			
P3342	33" X 42"	90			
P3648	36" X 48"	75			
P4464	44" X 64"	45			

Item # Size Bags/Roll **SAVE** 10%

MIX 'N MATCH ALL "CP" STYLES FOR QUANTITY PRICING

CP3647	36" X 47"	250			n/a
CP4464	44" X 64"	150			n/a

STRETCH WRAP with HANDLE

- Clear hand held roll of stretch wrap with sturdy handle.
- Protect your moulding or frames.
- No need to use tape for shipping or storage.
- Film clings to itself for a secure fit.
- 5" x 1000 ft/roll
- 12 rolls per case.



Item # 1 for 12+ @

867

HEAVY DUTY STRETCH WRAP

High performance. Clear hand held roll of stretch film. 3" Core. 2" wide x 600 ft/roll-120 gauge.



Item # 1 for 12+ @ **SAVE 10%**

392

HEAVY DUTY STRETCH WRAP

- Clear film perfect for banding
- Perfect for bundling packages together
- No need to use tape for shipping or storage
- Film clings to itself - no adhesives necessary
- 16" x 1500 ft/roll - 65 gauge
- 4 rolls per case



Item # 1 **SAVE 20%** 4 @

826

DuPont "Melinex 516" Mylar "D"



A high clarity clear polyester film which allows for good handling properties with high clarity and brilliance.

- Protects prints, art work, and much more.
- 0.003 gauge
- 42" x 100ft roll

Item # 1 roll

1335

PRINT HOLDERS

- Display 2 pictures at a time
- Ideal protection for artwork
- White removable low pH insert
- Heavy-duty 10mil non-flex vinyl
- Double stitched with clear sewn border
- Reusable



Item # Size 1/size **SAVE 10%** **SAVE 18%**

1403	16" x 20"			
1404	18" x 24"			
1405	20" x 26"			
1406	26" x 32"			
1407	30" x 40"			
1408*	32" x 43"			

* cannot ship via UPS

RESEALABLE CLEAR BAGS

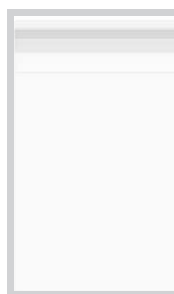

- Resealable flap
- Save labor costs of shrink wrapping
- Eliminates excessive handling of material
- Crystal clear polypropylene
- 1/4" allowance
- 100/pkg

Item #	Size	1 pkg
1318	5"x7"	<input checked="" type="checkbox"/>
1319	8"x10"	<input checked="" type="checkbox"/>
1320	8½"x11"	<input checked="" type="checkbox"/>
1321	11"x14"	<input checked="" type="checkbox"/>
1322	16"x20"	<input checked="" type="checkbox"/>
1323	20"x24"	
1324	22"x28"	
1325	24"x36"	
1326*	32"x40"	

*50/pkg

BUBBLE WRAP



Item #	Roll Size	1 roll	2+ rolls
SAVE 10%			
LARGE BUBBLE: 1/2"			
BW	24" x 250'		
BW12	12" x 250'		
BW48	48" x 250'		
SMALL BUBBLE: 3/16"			
BW12S	12" x 500'		
BW24S	24" x 500'		
BW48S	48" x 500'		

LIGHTWEIGHT POLY-FOAM

Rolls of lightweight polyfoam with perforations.

SAVE 10%

Item #	Description	1 roll	2 + @
PF	3/32"x24"x750' Roll		
PF12	3/32"x12"x750' Roll		



75 and 100 Gauge CENTERFOLD SHRINK FILMS - 500 feet



- Protect your prints, art and posters for retail display.
- High clarity.
- Low temperature shrink film.
- Excellent seam strength.
- Tear resistant.

75 Gauge Shrink film			100 Gauge Shrink film		
Item #	Roll Size	1 for	Item #	Roll Size	1 for
321	24"		1341	24"	
322	30"		1342	30"	
323	36"		1343	36"	

SHRINK SEALER / WRAP MACHINES

Requires no assembly. Just plug it in and you're ready to wrap. Lightweight, sleek and is built to last. Both units come complete with the ultra-light HotShot® adjustable temperature heat gun. 2-year limited warranty. 40" cap'y.



Item #	Desc.	1 for
1338	No timer	CALL
1339	Timer	CALL

VERTICAL PAPER CUTTERS

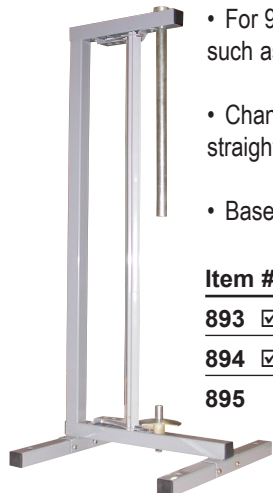

- For 9" diameter or smaller rolls on 3" core, such as kraft paper or Drymount tissue.
- Changing rolls is made easy by pulling the straight edge blade to an open locked position.
- Bases are designed to allow wheel posts.

Item #	Used for	Cost
893 <input checked="" type="checkbox"/>	18"-27" rolls	
894 <input checked="" type="checkbox"/>	30"-36" rolls	
895	40"-48" rolls	

KRAFT PAPER

A low cost, all purpose paper to cover the back of the frame to prevent damage. 40 lb. and 50 lb. natural kraft paper available in the following widths: 18", 24", 30", 36", 40", and 48".



Mix 'N Match for Quantity Pricing

Call for larger quantity discounts.

Item #	Paper Width	Basis Weight	Cost per roll	NOW 2+ / SAVE 10%
--------	-------------	--------------	---------------	-------------------

VIRGIN NATURAL KRAFT PAPER

18-40	18"	40 lbs.
24-40	24"	40 lbs.
30-40	30"	40 lbs.
36-40	36"	40 lbs.
36-50	36"	50 lbs.
40-50	40"	50 lbs.
48-50	48"	50 lbs.

RECYCLED KRAFT PAPER

24-50R	24"	50 lbs.
36-50R	36"	50 lbs.

BLACK KRAFT PAPER

1905	24"	50 lbs.
1907	36"	50 lbs.
1908	48"	50 lbs.

ALL-IN-ONE PAPER CUTTERS

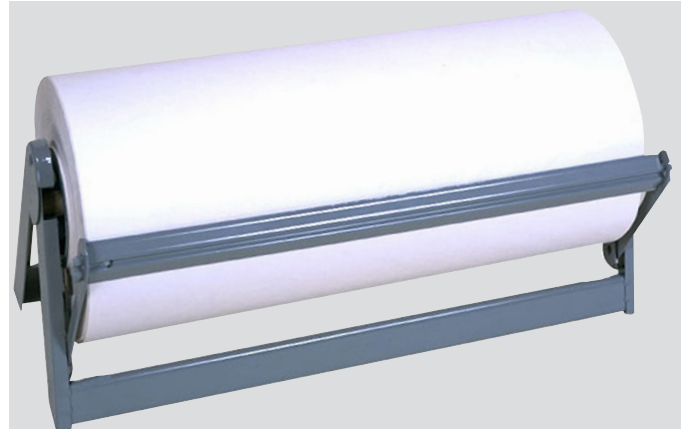

- Can be used as a kraft paper and plastic bag dispenser
- For 9" diameter or smaller rolls on 3" core.
- All steel construction with double edge tempered steel cutting blade.
- No assembly necessary. Spread the base and it's ready-for-use.
- Stands on a table, brackets to a wall and hangs from an overhang for easy operation.

Item #	Max. Roll Size	Cost
887 <input checked="" type="checkbox"/>	18"	
888 <input checked="" type="checkbox"/>	24"	
889 <input checked="" type="checkbox"/>	30"	
890 <input checked="" type="checkbox"/>	36"	
891 <input checked="" type="checkbox"/>	40"	
892 <input checked="" type="checkbox"/>	48"	

DECOR NICKEL PLATED GOODWILL COURTESY HANGERS

Everytime you hand your customer a finished frame, why not tape the correct size hanger on the back of it? We carry the complete line of courtesy hangers from 10 lb. picture weight capacity up to 100 lb. picture weight capacity.

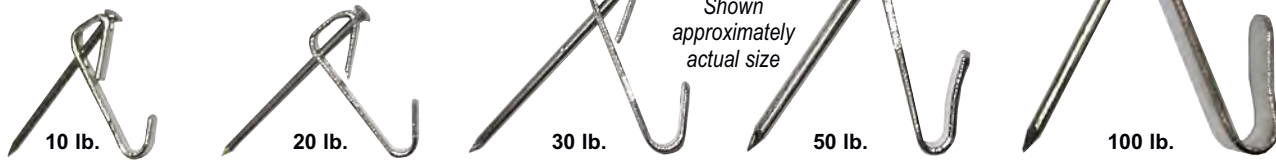

MIX 'N MATCH 100 pack Goodwill Hangers for Quantity Prices

Note on Polybag:
Thank You!
 Please accept this hanger as a token of our appreciation. It's the correct size for your hanging need and is part of our continuing effort to provide quality & service.

INDIVIDUAL POLY BAGS-100/pkg			
Item	Cap'y	1 box	4 box @
725 <input checked="" type="checkbox"/>	10 lb.		
726 <input checked="" type="checkbox"/>	20 lb.		
727 <input checked="" type="checkbox"/>	30 lb.		
728 <input checked="" type="checkbox"/>	50 lb.		
729 <input checked="" type="checkbox"/>	100 lb.		

Each polybag contains one hanger and one nail.

BULK PACKED - 1000	
Item	1 pack
725B	
726B	
727B	
728B	
729B	

Box contains 1000 hangers & 1000 nails in bulk.

EXTRA PINS				
100 pins/pkg.				
Item	Size	Fits	Price	10 +
1555 <input checked="" type="checkbox"/>	1" x 18	725/725B		
1556 <input checked="" type="checkbox"/>	1 1/8" x 17	726/726B		
1557 <input checked="" type="checkbox"/>	1 3/8" x 16	727/727B		
1558 <input checked="" type="checkbox"/>	1 3/4" x 14	728/728B		
1559 <input checked="" type="checkbox"/>	1 7/8" x 13	729/729B		

Save 20%

DECOR PREMIUM BRASS PLATED GOODWILL HANGERS

All brass hangers are individually polybagged with the appropriate number of brass capped hardened steel nails. 100 polybags/box. Your customers will appreciate this extra service.

Note on Polybag:
Thank You!
 Please accept this hanger as a token of our appreciation. It is the correct size for your hanging needs and is part of our continuing effort to provide quality and service.



1" Brass Capped Hardened Steel Pins



Item #882
 100/pk.
 10+ pk.

1" Brass Knurled Cap Hardened Steel Pins



Item #883
 100/pk.

INDIVIDUAL POLY BAGS - 100 polybags/box

Item	Cap'y	1 box	4 box @	8 box @
877 <input checked="" type="checkbox"/>	10 lb.			
878 <input checked="" type="checkbox"/>	20 lb.			
879 <input checked="" type="checkbox"/>	30 lb.			
880 <input checked="" type="checkbox"/>	50 lb.			
881 <input checked="" type="checkbox"/>	75 lb.			

BULK PACKED - 100/pack

Item	1 pack
872 <input checked="" type="checkbox"/>	
873 <input checked="" type="checkbox"/>	
874 <input checked="" type="checkbox"/>	
875 <input checked="" type="checkbox"/>	
876 <input checked="" type="checkbox"/>	

BULK PACKED

Item	Pack Qty.	1 pack
872T	1000	
873T	1000	
874T	500	
875T	500	
876T	250	

Bulk packed with brass capped hardened steel nails.

FLANGER™ HANGERS



Flanger Hanger has a flange on one side that grips the inside edge of the frame. This braces the hanger in position and helps prevent screw tear-out on narrow wood frames.

MIX 'N MATCH for Quantity Prices

Item	Back Mldg Width	Max Wt.	Box	1 for	3 @
1307 <input checked="" type="checkbox"/>	min. 1/4"+	25lbs.	50		
1308 <input checked="" type="checkbox"/>	1/2"-1"+	50lbs.	50		

Flanger hangers are supplied in sets, with a specific left and right hanger in each set, and 200 screws/box.

Hook-Ups! ADJUSTABLE PICTURE HANGERS

Now it's easy to hang pictures straight

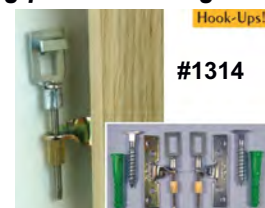

Hook-Ups! adjustable security picture hangers are a very flexible and versatile hanging system. These hangers are designed to work on wood or metal frames. They attach to each side of the frame to form a secure, wireless, two-point mounting system that will safely hold artwork weighing up to 100 pounds. Artwork can be leveled easily without removing the item from the wall.

Item	Desc.	1 pkg
1313 <input checked="" type="checkbox"/>	Standard	
Package includes 1 pair of Hook-Ups, hardware for wood and metal frames		
1314 <input checked="" type="checkbox"/>	Security	
Package includes 1 pair of Hook-Ups, hardware for wood and metal frames PLUS T screws and anchors		



Hangers are shown actual size.

Item #	Quan.	Price	Item #	Quan.	Price/Bx	2 +	5 +
705	<input checked="" type="checkbox"/>	100/box	705T	1000/box	\$75.99		
706	<input checked="" type="checkbox"/>	100/box	706T	1000/box			
707	<input checked="" type="checkbox"/>	100/box	707T	1000/box			
708	<input checked="" type="checkbox"/>	100/box	708T	1000/box			
709	<input checked="" type="checkbox"/>	100/box	709T	1000/box			
714	<input checked="" type="checkbox"/>	100/box	714T	1000/box			
715	<input checked="" type="checkbox"/>	100/box	715T	1000/box			
716	<input checked="" type="checkbox"/>	100/box	716T	1000/box			
1353	<input checked="" type="checkbox"/>	100/box	1353T	1000/box			
838	<input checked="" type="checkbox"/>	100/box	838T	1000/box			
839	<input checked="" type="checkbox"/>	100/box	839T	1000/box			

Note: 1000/box quantity is not part of the "Chop Friendly" program.

Super Steel Hangers



We recommend #4 screws (#436 or #437) for #838/#838T & #839/#839T. See page 30.



We recommend #419 / #419T 3/8" x #4 screws for use in #1353 / #1353T. See page 30.

DECOR SCREW EYES • Zinc plated • Packed 200/box or 1,000/bag

SHORT SHANK SCREW EYES LONG SHANK SCREW EYES

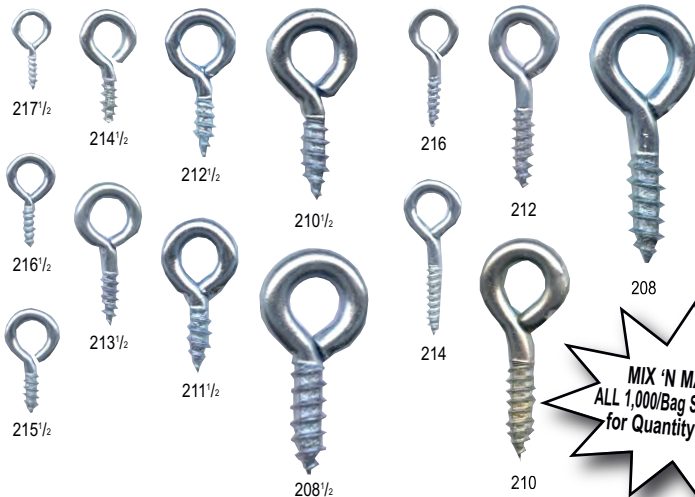

MIX 'N MATCH
ALL 1,000/Bag Screw Eyes
for Quantity Prices

SHORT SHANK SCREW EYES

Desc	Item #	200/box 1 Box	Item #	1,000/Bag 1 Bag	5 Bags @
217 1/2	730	<input checked="" type="checkbox"/>	741	<input checked="" type="checkbox"/>	
216 1/2	731	<input checked="" type="checkbox"/>	742	<input checked="" type="checkbox"/>	
215 1/2	732	<input checked="" type="checkbox"/>	743	<input checked="" type="checkbox"/>	
214 1/2	733	<input checked="" type="checkbox"/>	744	<input checked="" type="checkbox"/>	
213 1/2	734	<input checked="" type="checkbox"/>	745	<input checked="" type="checkbox"/>	
212 1/2	735	<input checked="" type="checkbox"/>	746	<input checked="" type="checkbox"/>	
211 1/2	736	<input checked="" type="checkbox"/>	747	<input checked="" type="checkbox"/>	
210 1/2	737	<input checked="" type="checkbox"/>	748	<input checked="" type="checkbox"/>	
208 1/2	738	<input checked="" type="checkbox"/>	749	<input checked="" type="checkbox"/>	

LONG SHANK SCREW EYES

216	750	<input checked="" type="checkbox"/>	755	<input checked="" type="checkbox"/>	
214	751	<input checked="" type="checkbox"/>	756	<input checked="" type="checkbox"/>	
212	752	<input checked="" type="checkbox"/>	757	<input checked="" type="checkbox"/>	
210	753	<input checked="" type="checkbox"/>	758	<input checked="" type="checkbox"/>	
208	754	<input checked="" type="checkbox"/>	759	<input checked="" type="checkbox"/>	

DECOR PREPACK PICTURE FRAME HANGING KIT

Individual polybag picture frame hanging kits. Easy to install.



#421 (3/8" x #6 Phillips PHS) #714 (One hole hanger) #740-4 #4 Braided Steel Wire 4 feet #727 (30lb Hanger)

Item #	Description	1	5+ @
926	<input checked="" type="checkbox"/> Prepack - 1 bag		
926H	<input checked="" type="checkbox"/> Prepack - 100 bags/box		
926T	Prepack - 1000 bags/box		

KEYHOLE HANGER



Zinc plated. Uses a 6 gauge Phillips head sheet metal screw #420 - #425 or #420T - #425T. Screws not included. 5/8" W x 1 13/16" H. 100/box

Item #	1	5+ @
1548	<input checked="" type="checkbox"/>	

S-Moulding Hooks



#1926 A great choice for galleries or anywhere a large quantity of hooks are required. 1 3/4" H x 3/16" W x .10" thick. Rail hook: 3/4" Dia. approx.
#2320 Economical way to hang your pictures in true, period style. Pressure-formed for added strength. 1 3/4" H x 1/2" W x .04" thick. Rail hook: 5/8" Dia. approx.

Item #	Qty.	1
1926	<input checked="" type="checkbox"/>	100
2320	<input checked="" type="checkbox"/>	100

See back cover for details Eff. 1/18/22

NAILESS SAWTOOTH HANGERS



Perfect for Hardwoods
NOW AVAILABLE
 in Zinc, Brass and Black

Item	Description	Pkg. Qty.	1 pack	5 +
405	<input checked="" type="checkbox"/> Zinc 1" long, 1/4" wide	100		
405T	<input checked="" type="checkbox"/> Zinc 1" long, 1/4" wide	1000		
406	<input checked="" type="checkbox"/> Zinc 2" long, 5/16" wide	100		
406T	<input checked="" type="checkbox"/> Zinc 2" long, 5/16" wide	1000		
407	<input checked="" type="checkbox"/> Brass 1" long, 1/4" wide	100		
407T	<input checked="" type="checkbox"/> Brass 1" long, 1/4" wide	1000		
408	<input checked="" type="checkbox"/> Brass 2" long, 5/16" wide	100		
408T	<input checked="" type="checkbox"/> Brass 2" long, 5/16" wide	1000		
409	<input checked="" type="checkbox"/> Black 1" long, 1/4" wide	100		
409T	<input checked="" type="checkbox"/> Black 1" long, 1/4" wide	1000		
410	<input checked="" type="checkbox"/> Black 2" long, 5/16" wide	100		
410T	<input checked="" type="checkbox"/> Black 2" long, 5/16" wide	1000		

Tap each leg separately and continue alternating until you have reached the desired depth. DO NOT hammer in the middle, as that will cause the middle to collapse.

OFFSET CLIPS with SCREWS Now with 2 holes



#546 #548 #549 #550

Shown approximately actual size



#551 #823 #824 #825

All of the following include #6 x 3/8" Phillips head screws.

BULK PACKED - 100

BULK PACKED - 1000

SAVE 10%

SAVE 10%

Item	Desc.	1 pack	5 @	Item	1 for	5 @
546	<input checked="" type="checkbox"/> 0/0"			546T		
548	<input checked="" type="checkbox"/> 1/8"			548T		
549	<input checked="" type="checkbox"/> 1/4"			549T		
550	<input checked="" type="checkbox"/> 3/8"			550T		
551	<input checked="" type="checkbox"/> 1/2"			551T		
823	<input checked="" type="checkbox"/> 3/4"			823T		
824	<input checked="" type="checkbox"/> 1"			824T		
825	<input checked="" type="checkbox"/> 1-1/4"			825T		

OFFSET CLIP Variety Kits

Item	Desc.	1 pack
815	<input checked="" type="checkbox"/> 25 each #548, #549, #550, #551	
816	<input checked="" type="checkbox"/> 25 each #823, #824, #825	

Includes #6 x 3/8" Phillips head screws.

SAWTOOTH HANGERS



#411 complete with 1/2" nails



#412 complete with 1/2" nails

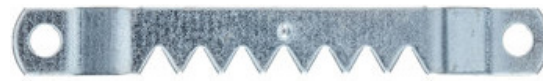

#413 complete with #422 (1/2"x#6) Phillips Pan Head screws

Shown approximately actual size

Item	Description	Pkg. Qty.	1 pack
411	<input checked="" type="checkbox"/> Zinc plated 1 5/8" long, 1/4" wide	100	
411T	<input checked="" type="checkbox"/> Zinc plated 1 5/8" long, 1/4" wide	1000	
412	<input checked="" type="checkbox"/> Zinc plated 2 3/4" long, 5/16" wide	100	
412T	<input checked="" type="checkbox"/> Zinc plated 2 3/4" long, 5/16" wide	1000	
413	<input checked="" type="checkbox"/> Zinc plated 2 3/4" long, 5/16" wide	100	
413T	<input checked="" type="checkbox"/> Zinc plated 2 3/4" long, 5/16" wide	1000	

WALLBUDDIES

Self-leveling Picture Hangers

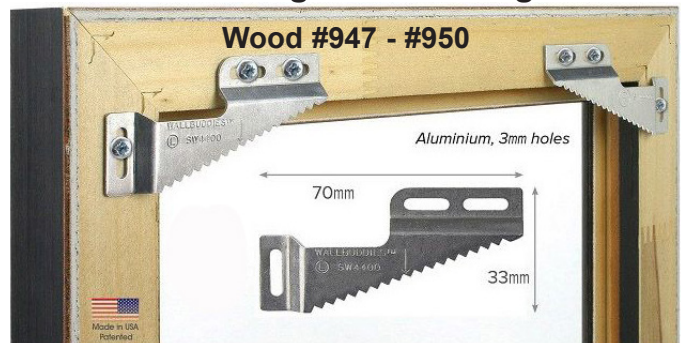

Easy to install and hang. Artwork stays level and secure against walls. Adds extra strength to frame corners. Eliminates product liability problems, such as broken wires and bowed frames. Allows you to hang easier, faster, and professionally.

Item	Wallbuddy #	Picture Weight	Quan.	Price Ea.
------	-------------	----------------	-------	-----------

WALLBUDDIES for Wood Frames

947	<input checked="" type="checkbox"/> 4400	30 lb.	1 pack	
948	<input checked="" type="checkbox"/> 4400	30 lb.	25 packs	
949	<input checked="" type="checkbox"/> 3300	60 lb.	1 pack	
950	<input checked="" type="checkbox"/> 3300	60 lb.	25 packs	

Each single wood package contains a complete set of 1 left and 1 right WallBuddie hanger, 2 super hooks and nails and 4 or 8 screws (screws not included in 25 packs).

WALLBUDDIES for Metal Frames

951	<input checked="" type="checkbox"/> 2200	30 lb.	1 pack	
952	<input checked="" type="checkbox"/> 2200	30 lb.	25 packs	

Each metal package contains a complete set of 1 left and 1 right WallBuddie hanger, 2 super hooks and 2 nails.

CANVAS SPRING CLIPS



Securely holds stretched canvas art in place in a frame, but also allows for easy removal. Just turn the spring clip and the pressure is removed from the back of the canvas.

Item	Desc.	Pack	Price
916	<input checked="" type="checkbox"/> 1/4" x 2"	100/bx	
916T	<input checked="" type="checkbox"/> 1/4" x 2"	1000/bx	
917	<input checked="" type="checkbox"/> 1/2" x 3"	100/bx	
917T	<input checked="" type="checkbox"/> 1/2" x 3"	1000/bx	

NOW BOXES of 100



Item	Quantity	Price	Item	Quantity	Price
Screw-in Hanger					
399 <input checked="" type="checkbox"/>	100/box		399T	1000/box	
Zinc Plated Tapped Corner Angle w/Set Screws inserted					
400 <input checked="" type="checkbox"/>	100/box		400T	1000/box	
Back Plate Angle to be used w/#400 (#400T)					
401 <input checked="" type="checkbox"/>	100/box		401T	1000/box	
3/8" Spring Clip-center notched					
402 <input checked="" type="checkbox"/>	100/box		402T	1000/box	
European Hanger w/Set Screw					
403 <input checked="" type="checkbox"/>	100/box		403T	1000/box	
Snap in Hanger after Frame is Assembled					
404 <input checked="" type="checkbox"/>	100/box		404T	1000/box	

Enough Hardware for 1 Frame

Item #1-SCREW		Item #1-SNAP	
Includes:		Includes:	
Item #	Qty	Item #	Qty
#400	4 Pcs.	#400	4 Pcs.
#401	4 Pcs.	#401	4 Pcs.
#402	8 Pcs.	#402	8 Pcs.
#403	2 Pcs.	#404	2 Pcs.
Bumpers	4 Pcs.	Bumpers	4 Pcs.

SAVE 10%

Item #	1 @	10 + @
1-SCREW <input checked="" type="checkbox"/>		
1-SNAP <input checked="" type="checkbox"/>		

Enough Hardware for 100 Frames

Item #100-SCREW		Item #100-SNAP	
Includes:		Includes:	
Item #	Qty	Item #	Qty
#400	400 Pcs.	#400	400 Pcs.
#401	400 Pcs.	#401	400 Pcs.
#402	800 Pcs.	#402	800 Pcs.
#403	200 Pcs.	#404	200 Pcs.
Bumpers	400 Pcs.	Bumpers	400 Pcs.

SAVE 5% SAVE 10%

Item #	1 @	2 + @	5 + @
100-SCREW			
100-SNAP			

NIELSEN Brand Hardware

METAL FRAME HARDWARE

All frame hardware is packed 100/pkg.

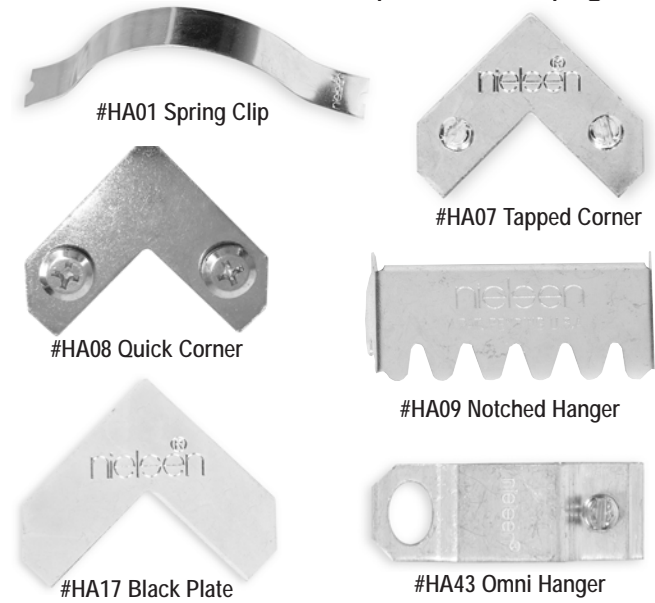

Item	Description	1	5	10
HA01	3/8" Spring Clip			
HA07	Tapped Corner			
HA08	Quick Corner			
HA09	Notched Hanger			
HA17	Back Plate			
HA43	Omni Hanger			

Bulk Pack for 100 FRAMES
HA63

Contains all the components to assemble 100 frames without the hanger: 800 ea. #HA01 Spring Clip, 400 ea #HA07 Tapped corner and 400 ea. #HA17 Back Plate and rubber bumpers. Be sure to order your hangers in addition to your order for bulk corners.

SECURITY HANGER SYSTEM



A quality security hanging system designed for use with Nielsen and other aluminum picture frame mouldings. Designed for a wide variety of applications where safe and secure picture hanging is necessary, such as commercial buildings in reception rooms, public hallways, restaurants, hotel rooms, offices or any other commercial or industrial location. A special security key is needed to remove the frame from the wall, discouraging movement or stealing.

Item	Package	1	5	10
HA2362 <input checked="" type="checkbox"/>	Individual box for 1 Metal frame			
	2 Security Top Hooks, 1 Security Hanger Key and 1 Security Lock			

Wall Anchors for T-Screw (#547), 1" x #8 Phillips Head, Pan Head SMS Screws (#426), and White Anchors (#516) are sold separately on pages 29 & 30.

HARDWARE for 1 FRAME

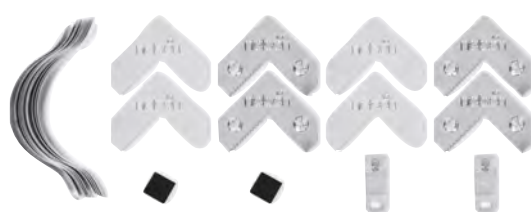

Item #	1 bag	10 bags @
HA4361		

Metal hardware poly-bag contains enough Nielsen brand hardware to assemble one metal frame:

- 4 ea. #HA07 tapped corners
- 4 ea. #HA17 back plates
- 10 ea. #HA01 spring clips
- 2 ea. #HA43 Omni hangers
- 2 ea. metal bumpers

PICTURE WIRE and More ...

SURFLON Nylon Coated Stainless Steel Crimping Wire & Accessories



Metal Sleeves

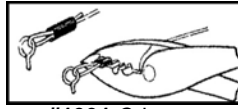

#1391 Crimper

Stainless steel nylon coated wire
Saves time by eliminating wire wrapping process
Metal sleeves never rust
Crimper tool acts as a wire cutter
1,000 feet/spool

First time user:

Purchase wire, sleeves and crimper. Thereafter, just wire or sleeves as needed.

Item#	Size/Desc.	Max. Weight	1	3+
1384	<input checked="" type="checkbox"/> 2	30 lbs.		
1385	<input checked="" type="checkbox"/> 3	40 lbs.		
1388	<input checked="" type="checkbox"/> #2/#3 sleeves			
1386	<input checked="" type="checkbox"/> 4	60 lbs.		
1389	<input checked="" type="checkbox"/> #4 sleeves			
1387	<input checked="" type="checkbox"/> 7	105 lbs		
1390	<input checked="" type="checkbox"/> #7 sleeves			
1391	<input checked="" type="checkbox"/> 9 1/2" Crimper Plier			

All wire 6 roll max./order

MIRACLE CORD PICTURE WIRE



Made of Twaron®, an innovative synthetic fiber that is stronger than steel with exceptional flexibility. It is not stiff or twisty. Very user-friendly, it will not prick your fingers or corrode or kink. Black cord is easy to handle, easy to attach and exceptionally strong and secure. It will

NOT stretch or slip. Stronger than common picture wire, very pleasant to handle, non-corrosive and combined with our unique Quick-Clip attachment method makes this the best and most advanced system for hanging most frames. The clean, attractive finished look is a major plus. Tested and proved by framers for 20 plus years.

Item #	Description	Uses Clip #	Appx ft. per Spool	Pic. Wt.	1 Roll
1345	<input checked="" type="checkbox"/> Light Cord Ideal size for smaller frames and narrow moldings.	1348	1200'	20 lbs.	
1346	<input checked="" type="checkbox"/> Regular Cord Ideal size for most regular size frames and moldings.	1349	1000'	40 lbs.	
1347	<input checked="" type="checkbox"/> Heavy Cord Ideal size for most large heavy frames and moldings. Clip uses two screws for added strength or where wood molding is soft.	1350	600'	80 lbs.	

QUICK CLIP ATTACHMENT SYSTEM

Just knot the cord and snap it in place. Softly rounded, the low-profile clip is black like the cord and is very strong.

#1348 Quick Clip Jr. uses wire #1345

#1349 Quick Clip I uses wire #1346

#1350 Quick Clip II uses wire #1347

Attaching Quick Clip to frame

Item #	Description	Pkg/Box	Uses Wire #	1 Pkg
1348	<input checked="" type="checkbox"/> Quick Clip Jr.	200 w/black screws	1345	
1349	<input checked="" type="checkbox"/> Quick Clip I	100 w/black screws	1346	
1350	<input checked="" type="checkbox"/> Quick Clip II	100 w/black screws	1347	

DECOR SUPER WIRE CUTTER

This tool has diagonal cutting jaws to reduce frayed ends and cuts effortlessly through SuperSoftstand, Softstrand and all other brands of picture wire (ie. all sizes of braided wire, stranded wire, and coated wire). It has a built-in spring for quick, easy cutting and heavy duty construction provides dependable, long-lasting use. It is a great tool for any framing workshop.

Item #1344



HEAT SHRINKABLE WIRE WRAPS

WireWraps are heat shrinkable black wire covers that end frayed picture wire and add a safe professional touch to framing jobs. Simply feed the wire through a pair of WireWraps before running them through the picture hooks, slide the WireWraps over the wrapped wire sections and shrink wrap tightly over the wire using a hot air gun.

Mix 'N Match for Quantity Prices

Item	Fits Wire	Diam*	1 pkg	15 pkgs.
1315	<input checked="" type="checkbox"/> 1 - 4	1/8"		
1316	<input checked="" type="checkbox"/> 4 - 6	3/16"		
1317	<input checked="" type="checkbox"/> 6 - 8	1/4"		

* before shrinking
Each package contains 10, 4" pieces



PICTURE WIRE



DECOR BRAIDED PICTURE WIRE

- Guaranteed to be the highest quality galvanized braided steel picture frame wire
- 5 lb. spools

Item#	Size	Strands	Breaking Strength	Max. Picture Weight	Approx. Ft. Per Spool
740-2	2	12	51 lbs.	12 lbs.	1500'
740-3	3	16	68 lbs.	16 lbs.	1125'
740-4	4	20	85 lbs.	20 lbs.	850'
740-5	5	24	102 lbs.	24 lbs.	750'
740-6	6	28	119 lbs.	28 lbs.	625'
740-8	8	36	145 lbs.	36 lbs.	500'

Mix 'N Match for Quantity Prices-Price per Roll
 1 Roll 3 + Rolls 6+ Rolls 12 + Rolls

All wire 6 roll max./order

DURA-LON™ Plastic Coated Stainless Steel Picture Wire



- Dura-Lon™ vinyl coating is smooth on your fingers - easy to twist
- Soft, flexible and strong
- Vinyl coating prevents wire slippage, does not rust or mark walls.
- Made from high-strength, corrosion resistant stainless steel

Mix 'N Match for Quantity Prices-Price per Roll
 1 Roll 3 + Rolls 6+ Rolls

Item#	Size	Max. Picture Weight	Approx. Ft. Per Spool
819	#2	15 lbs.	1500'
820	#3	20 lbs.	1125'
821	#4	25 lbs.	850'
822	#5	43 lbs.	500'
817	#6	60 lbs.	275'
818	#8	100 lbs.	125'

All wire 6 roll max./order

DECOR STAINLESS STEEL

- Stainless steel
- Easy to wrap.
- Softer and smoother than braided galvanized wire.
- Equal in strength to galvanized wire at almost half the size.
- Higher strength and greater flexibility eliminates broken wires and frayed ends.



Mix 'N Match for Quantity Prices-Price per Roll
 1 Roll 3 + Rolls 6+ Rolls

Item#	Size	Breaking Strength	Max. Picture Weight	Approx. Ft. Per Spool
829	2	51 lbs.	20 lbs.	1125'
830	3	68 lbs.	30 lbs.	825'
831	4	85 lbs.	35 lbs.	625'
832	5	102 lbs.	40 lbs.	550'
833	6	119 lbs.	50 lbs.	465'
834	8	153 lbs.	60 lbs.	375'
835	9	250 lbs.	100 lbs.	185'

All wire 6 roll max./order

SOFTSTRAND

- Stainless steel
- Easy to wrap.
- Softer & smoother than braided galvanized wire.
- Higher strength & greater flexibility eliminates broken wires and frayed ends.
- Equal in strength to galvanized wire at almost half the size.



Item#	Breaking Strength	Max. Picture Weight	Approx. Ft. Per Spool
PH2	51 lbs.	20 lbs.	1125'
PH3	68 lbs.	30 lbs.	825'
PH4	85 lbs.	35 lbs.	625'
PH5	102 lbs.	40 lbs.	550'
PH6	119 lbs.	50 lbs.	465'
PH8	153 lbs.	60 lbs.	375'
PH9	250 lbs.	100 lbs.	185'

Mix 'N Match for Quantity Prices
 Price per Roll
 1 Roll 3+ Rolls 6+ Rolls

All wire 6 roll max./order

SUPER SOFTSTRAND

- Plastic coated stainless steel is softer and easier to wrap than braided and plastic coated galvanized wire.
- Kink resistant plastic coating easily positions & adjusts on wall hanger.
- Highest strength and greater flexibility eliminates broken wires and frayed ends.



Item#	Max. Picture Weight	Approx. Ft. Per Spool
PS2	15 lbs.	1500'
PS3	20 lbs.	1125'
PS4	25 lbs.	850'
PS5	43 lbs.	500'
PS6	60 lbs.	275'
PS8	100 lbs.	125'

Mix 'N Match for Quantity Prices
 Price per Roll
 1 Roll 3 + Rolls 6+ Rolls

All wire 6 roll max./order

DECOR CLEAT HANGING BARS for HEAVY FRAMES



NOW available
6", 12", 18"
24", 36" & 48"
pre-cut strips

CAN SHIP UPS

Easy to cut-to-size extruded aluminum with oval **pre-drilled mounting holes every 4"** for easy mounting on walls or into wall studs for maximum strength. Hangs tightly to the wall. Designed for heavy and oversized frames, framed mirrors, or cabinets and heavy objects for commercial or residential applications. *Two bars are needed per framing application: one for the frame, one for the wall.*

Instructions: Attach one bar to the top of the picture frame. We recommend using a Decor #422, 1/2" x #6, Phillips Pan Head Sheet Metal Screw or longer, depending on the frame thickness. Attach the other bar to the wall, using a level to ensure that the frame will hang correctly. We recommend using Decor #426, 1" x #8 Pan Combo Sheet Metal Screws with Decor #516 Wall Anchors.

To **securely** hang 1 frame using two 12" cleat bars (#765) per frame, we recommend:

- 1- #511 Security Slotted Brackets
 - 1- #509 Security T-Screw
 - 5- #422 1/2" x #6 Phillips Pan Head Sheet Metal Screws
 - 3- #426 1" x #8 Phillips Screws to attach 12" cleat bar to wall
 - 3- #516 Wall anchors to use with #426 screws
- 1- #508 Security Wrench*
1- #547 Wall Anchor for T-Screw #509
to attach cleat bar and security slotted bracket to frame.
- You can make the 12" cleat bar more secure by using 1 each additional of the following: #422 screw, #426 screw and #516 anchor.*

Item	Length	SAVE 10% SAVE 20%		
		Min 4 pcs.	10 pcs.	20 pcs.
STANDARD CLEAT: 1.2mm thick <= 90lbs				
870	59"			
SUPER CLEAT: 2.0mm thick >= 90lbs				
871	59"			

Item	Length	Pkg'g	SAVE 10% SAVE 20%		
			1 pkg	4+ pkg	10+ pkgs
PREMIUM CLEAT: 1.5mm thick - Pre-packs					
1537	6"	20 pcs			
765	12"	20 pcs			
1547	18"	16 pcs			
1538	24"	12 pcs			
1539	36"	8 pcs			
1540	48"	6 pcs			

DECOR CLEAT BAR Security System

SAVE 20% 1 bag of #991 is good for 1 frame installation for up to 12" cleat bars.

Item	1 pkg	100+ pkg
991	<input checked="" type="checkbox"/> Hardware Set	
992	<input checked="" type="checkbox"/> (2) 6" Cleat Bars + Hardware Set	
993	<input checked="" type="checkbox"/> (2) 12" Cleat Bars + Hardware Set	

- Includes:**
- 1 - #511 Security Slotted Bracket to attach to the bottom of the frame
 - 1 - #509 Security T-Screw
 - 1 - #547 Wall anchor for T-Screw #509 to attach to the wall.
 - 5 - #422 1/2" x 6 Phillips Screws. 2 to attach cleat bar to the frame and 2 for Security Slotted Bracket #511 to attach to frame.
 - 3 - #426 1" x 8 Phillips Screws to attach cleat bar to the wall
 - 3 - #516 Wall anchors to use with #426 screws to attach cleat bar to the wall
- *Requires Security Wrench for T-Screw #508 (Sold Separately-page 29)*



SECURITY HANGERS for WOOD MOULDINGS

Item #904 **SINGLE POLY BAG:** \$1.13/bag
Includes:
1 set of brackets
4 - #432 1/2" x #6 wood screws for frame mounting bracket
4 - #435 1" x #6 wood screws for wall mounting bracket
4 - #516 wall anchors

This 2-piece mounting bracket is perfect for heavy frames and mirrors. Wall mounting bracket with security spring facing up is mounted to the wall. The frame mounting bracket, with the inner leg facing down, is mounted to the frame. They interlock easily and quickly and insure a strong, secure hanging system.

Item #905 BULK for 100 FRAMES:
1 box **SAVE 10%** 5 boxes



WOOD & METAL SECURITY HANGERS

Perfect for hotels/motels and public places where security is needed for wood mouldings. Quickly locks objects to walls and easily removes for paintings, maintenance and metal remodeling.

For Wood Mouldings - This tamper resistant hanger is for wood moulding where security is desired.

ALL ILLUSTRATIONS SHOWN APPX. ACTUAL SIZE



Item #504 Single poly bag

Item #505 Bulk for 100 Wood frames.

Includes: **SAVE 10%** 5 +
Slide-in Mounting Brackets #510 (2 each), Security T-Screw #509 (1 each), Wall Anchors #547 for T-Screws (1 each), Security Slotted Brackets #511 (3 each), 1/2" x #6 Phillips Pan Head SMS screws #422 (6 each), 1" x #8 Phillips Head, Pan Head SMS screws #426 (2 each), White Anchor #516 (2 each).
Need to order wrench #508 (see below).

Includes: **SAVE 10%**
Slide-in Mounting Brackets #510 (200 each), Security T-Screw #509 (100 each), Wall Anchors #547 for T-Screws (100 each), Security Slotted Brackets #511 (300 each), 1/2" x #6 Phillips Pan Head SMS screws #422 (600 ea), 1" x #8 Phillips Head, Pan Head SMS screws #426 (200 each), White Anchor #516 (200 each).
Includes wrench #508 (see below).

For Metal Mouldings - These fit any common metal moulding profile.

ALL ILLUSTRATIONS SHOWN APPX. ACTUAL SIZE



Item #506 Single poly bag

Item #507 Bulk for 100 Metal frames.

Includes: **SAVE 10%**
Slide-in Mounting Brackets #510 (2 each), Security T-Screws #509 (1 each), Wall Anchors #547 for T-Screws (1 each), 1" x #8 Phillips Head, Pan Head SMS screws #426 (2 each), White Anchor #516 (2 each).
Need to order wrench #508 (see below).

Includes:
Slide-in Mounting Brackets #510 (200 each), Security T-Screws #509 (100 each), Wall Anchors #547 for T-Screws (100 each), 1" x #8 Phillips Head, Pan Head SMS screws #426 (200 each), White Anchor #516 (200 each).
Includes wrench #508 (see below).

ACCESSORIES for WOOD and METAL SECURITY HANGERS

Item #	Description	Price
508 <input checked="" type="checkbox"/>	Wrench for Security Hangers For use with #504 and #506	
509 <input checked="" type="checkbox"/>	Security T-Screws (10 pack)	
509H <input checked="" type="checkbox"/>	Security T-Screws (100 pack)	
509T	Security T-Screws (1000 pack) Use Decor #547 Wall Anchor (2 T-Screws are recommended for frame sizes larger than 24" wide)	
510 <input checked="" type="checkbox"/>	Slide-in Mounting Bracket (10 pack)	
510H <input checked="" type="checkbox"/>	Slide-in Mounting Bracket (100 pack)	
510T	Slide-in Mounting Bracket (1000 pack) Uses Decor #426 screws and Decor #516 Wall Anchors.	

Item #	Description	Price
511 <input checked="" type="checkbox"/>	Security Slotted Bracket (10 pack)	
511H <input checked="" type="checkbox"/>	Security Slotted Bracket (100 pack)	
511T	Security Slotted Bracket (1000 pack) For use with #509 Security T-Screws. Uses Decor #422 screws.	
516 <input checked="" type="checkbox"/>	White Anchors (10 pack)	
516H <input checked="" type="checkbox"/>	White Anchors (100 pack)	
516T <input checked="" type="checkbox"/>	White Anchors (1000 pk) for Decor's #425, #435, #445 #1x6 and Decor's #426 #1x8 screws.	
547 <input checked="" type="checkbox"/>	Anchors for T-Screws (10 pack)	
547H <input checked="" type="checkbox"/>	Anchors for T-Screws (100 pack)	
547T <input checked="" type="checkbox"/>	Anchors for T-Screws (1000 pack) For use with #509 T-Screws.	

WOOD FRAME HARDWARE

STEEL PLATES



CORNER ANGLES

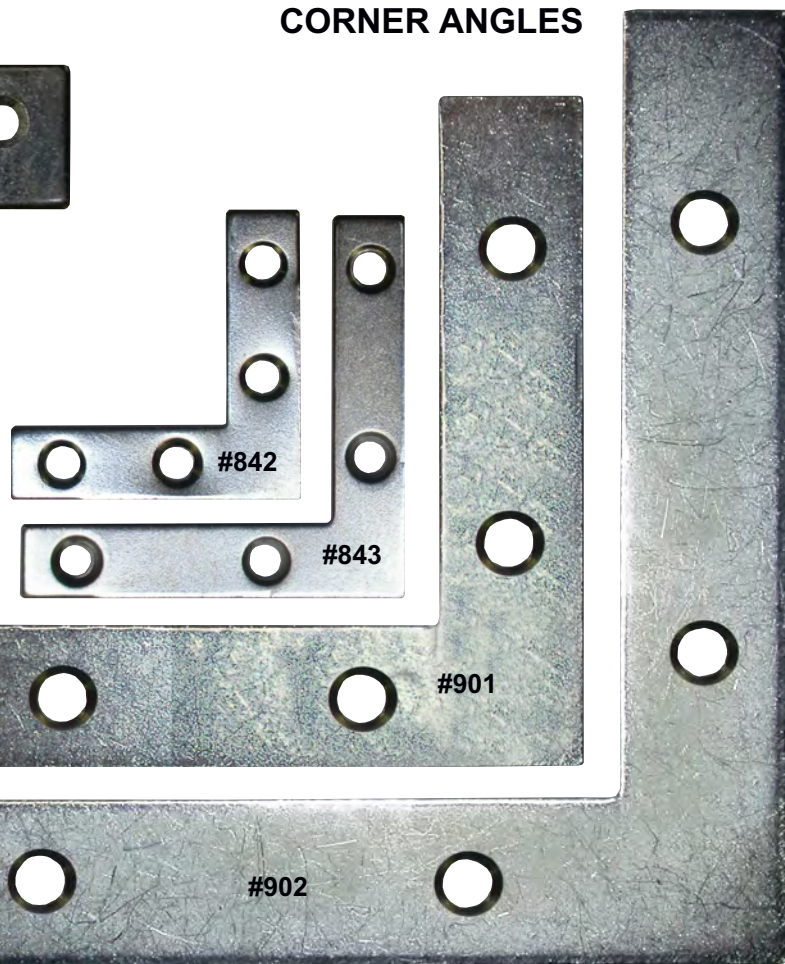

Item	Description	1 for
#760	<input checked="" type="checkbox"/> 1"x1"x1/2" inside corner angle	100 pack
#840	<input checked="" type="checkbox"/> 2"x1/2" 2 hole plate	100 pack
#841	<input checked="" type="checkbox"/> 3"x3/4" 4 hole plate	100 pack
#842	<input checked="" type="checkbox"/> 1/2"x1 1/2"x3/8" corner	100 pack
#843	<input checked="" type="checkbox"/> 2"x2"x3/8" corner	100 pack
#901	<input checked="" type="checkbox"/> 3 1/2"x3 1/2"x1/4" corner	48 pack
#902	<input checked="" type="checkbox"/> 5"x5"x1/8" corner	48 pack

We recommend 1/2"x#6,
Decor #432 Flat Head Wood Screws.

INSIDE CORNER ANGLE



Shown approximately actual size

PHILLIPS HEAD SCREWS



Item #419-429
Phillips Head, Pan Head
Sheet Metal Screw

Item #426
Phillip Head
Pan Head
Sheet Metal Screw

Item #431-437
Phillips Head,
Flat Head
Wood Screw

Item #442-445
Phillips Head,
Round Head
Wood Screw

Item #	Size	Packed Price/100	Item #	Packed Price/1000	5000 +
--------	------	------------------	--------	-------------------	--------

PHILLIPS HEAD, PAN HEAD SHEET METAL SCREWS

419	<input checked="" type="checkbox"/> 3/8" x #4	419T	<input checked="" type="checkbox"/>
420	<input checked="" type="checkbox"/> 1/4" x #6	420T	<input checked="" type="checkbox"/>
421	<input checked="" type="checkbox"/> 3/8" x #6	421T	<input checked="" type="checkbox"/>
422	<input checked="" type="checkbox"/> 1/2" x #6	422T	<input checked="" type="checkbox"/>
423	<input checked="" type="checkbox"/> 5/8" x #6	423T	<input checked="" type="checkbox"/>
424	<input checked="" type="checkbox"/> 3/4" x #6	424T	<input checked="" type="checkbox"/>
425	<input checked="" type="checkbox"/> 1" x #6	425T	<input checked="" type="checkbox"/>

Item #	Size	Packed Price/100	Item #	Packed Price/1000
PHILLIPS HEAD, PAN HEAD SHEET METAL SCREWS				
427	<input checked="" type="checkbox"/> 1/2" x #8	427T	<input checked="" type="checkbox"/>	
428	<input checked="" type="checkbox"/> 5/8" x #8	428T	<input checked="" type="checkbox"/>	
426	<input checked="" type="checkbox"/> 1" x #8	426T	<input checked="" type="checkbox"/>	
429	<input checked="" type="checkbox"/> 1" x #10	429T	<input checked="" type="checkbox"/>	

PHILLIPS HEAD, FLAT HEAD WOOD SCREWS

436	<input checked="" type="checkbox"/> 1/2" x #4	436T	<input checked="" type="checkbox"/>
437	<input checked="" type="checkbox"/> 3/4" x #4	437T	<input checked="" type="checkbox"/>
431	<input checked="" type="checkbox"/> 3/8" x #6	431T	<input checked="" type="checkbox"/>
432	<input checked="" type="checkbox"/> 1/2" x #6	432T	<input checked="" type="checkbox"/>
433	<input checked="" type="checkbox"/> 5/8" x #6	433T	<input checked="" type="checkbox"/>
434	<input checked="" type="checkbox"/> 3/4" x #6	434T	<input checked="" type="checkbox"/>
435	<input checked="" type="checkbox"/> 1" x #6	435T	<input checked="" type="checkbox"/>

PHILLIPS HEAD, ROUND HEAD WOOD SCREWS

446	<input checked="" type="checkbox"/> 1/2" x #4	446T	<input checked="" type="checkbox"/>
447	<input checked="" type="checkbox"/> 3/4" x #4	447T	<input checked="" type="checkbox"/>
442	<input checked="" type="checkbox"/> 1/2" x #6	442T	<input checked="" type="checkbox"/>
443	<input checked="" type="checkbox"/> 5/8" x #6	443T	<input checked="" type="checkbox"/>
444	<input checked="" type="checkbox"/> 3/4" x #6	444T	<input checked="" type="checkbox"/>
445	<input checked="" type="checkbox"/> 1" x #6	445T	<input checked="" type="checkbox"/>

See back cover for details

Eff. 1/20/22

SWISS CLIPS

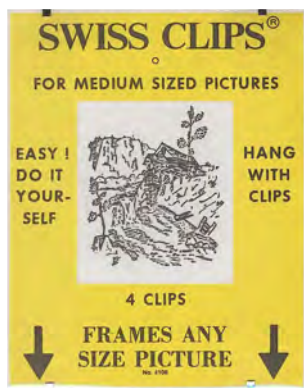

Spring loaded arms of stainless steel clips hold up to 30"x30" glass, picture, matboard and backing. Good for one picture. Hangs with 4 clips (included per pkg.). 3/8" maximum thickness.

SAVE 5%

Item #	Description	Price	10 @
1491	Complete Set-medium frames up to 30" x 30"		
1492	100 Swiss Clips		

SWISS CORNER CLIPS KIT



Close-up of Swiss Corner Clip

Frames any size picture up to 30" x 30". Four clips firmly clamp thicknesses up to 7/16" thick of glass, picture and backing. Good for one picture. Max 60lbs. Kit includes four stainless steel Swiss Clips, four stainless steel Swiss Corner Clips, string, and a hanging bracket.

SAVE 5%

Item #	Description	Price	10 @
1493	Complete Kit-frames up to 20" x 20" includes 4 corners + 4 clips		
1494	Complete Kit corners + 4 clips		
1495	60 Swiss Corner Clips		
1497	Swiss Clip Cord - 150ft. (for #1495)		
1496	Complete Set-large frames up to 40" x 40" includes 4 corners, 4 clips and cord		

FABRIC FASTENING KIT



#1501 Fine fabric tag gun

#1498 Micro-Stitch tag gun



#1503 1/4" fasteners T-End



#1504 1/2" fasteners T-End

shown appx. actual size

Fasten-IT is the quick-and-easy way to mount fabric articles. Time efficient and hassle-free. It allows you to quickly and accurately complete fabric and garment framing jobs. Now, those time-consuming athletic shirts, jackets, hankies, hats and doilies, that once took hours of sewing time, can now be mounted and ready-to-frame in a fraction of the time. Fasten-IT works on all types of clothing articles, tapestry, quilts and some types of needlework.

Item #	Description	Price
1505	FAS-N-IT Complete Kit includes: #1498 Micro-Stitch Tag Gun, #1499 Micro-stitch needle (1), #1500 Micro-stitch fasteners-1,080 pcs (9 clips @ 120 fasteners/clip), #1501 Fine Fabric Tag Gun, #1502 Fine Fabric needle (1), #1503 1/4" fine fabric fasteners-2,000 pcs (40 clips @ 50 fasteners/clip), #1504 1/2" fine fabric fasteners-2,000 pcs (40 clips @ 50 fasteners/clip), and Owner's Manual (for Micro-Stitch Tag Gun)	\$

ACCESSORIES:

1498	Micro-Stitch Tag Gun with 1,080 fasteners
1499	Micro-stitch replacement needles (2)
1500	Micro-stitch T-End white fasteners (2,040 pieces) (17 clips @ 120 fasteners/clip)
1501	Fine Fabric Tag Gun
1502	Fine Fabric replacement needles (2)
1503	1/4" fine fabric white fasteners, T-End (2,000 pieces) (40 clips @ 50 fasteners/clip)
1504	1/2" fine fabric white fasteners, T-End (2,000 pieces) (40 clips @ 50 fasteners/clip)

DECOR MINI FRAME PACKAGES

Joined Frames at Length Prices

Each Mini Frame (MF) package contains 25 joined frames of a size in assorted profiles and finishes.

- Each frame is fully assembled - joined, glued and V-nailed.
- Corners are not filled.
- Packages are prepacked. They cannot be customized to specific styles and profiles.

Style No.	Size	Price
MF57	5" x 7"	
MF80	8" x 10"	
MF92	9" x 12"	
MF14	11" x 14"	
MF26	12" x 16"	
MF11	14" x 18"	
MF60	16" x 20"	

☑ See back cover for details

Eff. 9/6/22

SPRAY PAINTS by KRYLON

"No Fluorocarbons" • "Not Harmful to Ozone"

Item #	Color	Item #	Color
457 <input checked="" type="checkbox"/>	Ultra Flat Black	465 <input checked="" type="checkbox"/>	Satin Black
459 <input checked="" type="checkbox"/>	Cherry Red	471 <input checked="" type="checkbox"/>	White Primer
461 <input checked="" type="checkbox"/>	Glossy Black	478 <input checked="" type="checkbox"/>	Silver Metallic
462 <input checked="" type="checkbox"/>	Glossy White		



Item #	Price	12 +	36 +
See above <input checked="" type="checkbox"/>			

Other colors available on special order.
Items 450 - 478 can be combined for quantity discount.

GRAPHIC ARTS SPRAYS & ADHESIVES

Item #	Krylon #	Description	from KRYLON
450 <input checked="" type="checkbox"/>	1303	Crystal Clear Acrylic Applies clear, stays clear. A permanent protection for drawings, prints, etc. Non-yellowing.	
451 <input checked="" type="checkbox"/>	1305	UV-Resistant Clear Acrylic Coating Crystal clear acrylic applies clear, stays clear. A permanent protection for drawings, prints, etc. Non-yellowing.	
452 <input checked="" type="checkbox"/>	1312	Kamar Varnish Revives dull "sunken-in" colors. Hard finish, high gloss, durable, lasting protection.	
453 <input checked="" type="checkbox"/>	1306	Workable Fixatif Fixes pencil, charcoal, chalk, pastels, remain clear. Ideal surface for res-work or art revision. Compatible with tempera colors, india ink, etc.	
454 <input checked="" type="checkbox"/>	1311	Matte Finish Non gloss finish, eliminates glossy sheen and light reflection, for use on black, white and color surfaces.	
455 <input checked="" type="checkbox"/>	7002	Satin Varnish	
475 <input checked="" type="checkbox"/>	7010	High Tack Adhesive - 11oz. All-purpose, nonstaining, high strength, extended open tack time, even spray pattern.	
476 <input checked="" type="checkbox"/>	7020	Repositionable Adhesive (Easy-Tack™) Adjust, remove or reapply throughout life of the bond, low odor, ideal for light weight materials. 10.25 oz.	
Item #	Price	12 +	36 +

See above
Items 450 - 478 can be combined for quantity discount.



SPRAYWAY™ PLASTIC SPRAY CLEAR FIXATIVE

Clear acrylic protective coating **stays clear** under any condition. Contains "UV" protectant inhibitors which keep artwork from fading. Protects valuable papers, books, maps, documents, carbon copies, artwork, proofs, photos, blueprints, watercolors, pastels, charcoals, pencil and ink renderings from aging, yellowing or smudging. Is water repellent. No ozone depleting chemicals. GW 16oz. Net wt. 10.5 oz.

Item # 633

SPRAY CAN HANDLE

Item # 474

Convert any aerosol to a spray can. Handle easily attaches and removes from aerosol cans.



PUSH-PIN SERVICE

for chops from 1/2" to 4" Wide*

Decor offers an economical alternative for joining frames. PUSH-PIN. Corners are routed for plastic inserts which are shipped along with your chops. This system doesn't require a vise and eliminates drilling and nailing.

* Please note that certain shape moulding profiles do not allow themselves to be used with this system.

Item #	# of Push-Pins	Moulding Width	Price
PP1 <input checked="" type="checkbox"/>	1	1/2" to 1"	
PP2 <input checked="" type="checkbox"/>	2	1" to 2"	
PP3 <input checked="" type="checkbox"/>	3	2" to 4"	

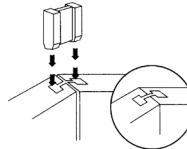

THUMBNAIL INSERTS

Item #	Size	Inserts per Bag	Price
600 <input checked="" type="checkbox"/>	3/8" Small	500	
601 <input checked="" type="checkbox"/>	5/8" Medium	500	
602 <input checked="" type="checkbox"/>	15/16" Large	250	

nelsen ROUTER BIT



Item #	Description	NOW ONLY
603 <input checked="" type="checkbox"/>	Long Life Carbide Bit 1 1/2" long, 1/4" shank	

un-du® ADHESIVE REMOVER

Safely removes all mounting adhesives such as ATG Tapes, Spray Mount adhesives, heat activated foamboards and more. Removes pesky stickers, tapes and labels. Works very well on stains, candle wax, goo, tar, tree sap, scuff marks and more. Removes adhesive residue from press platens.



- No staining or residue left behind.
- Acid-free and photo safe. Removes finger prints from the front of photos.

Style #	Size	1 for
899 <input checked="" type="checkbox"/>	4 oz. (Scraper tool included)	
900 <input checked="" type="checkbox"/>	32 oz.	

UNSTIK ADHESIVE RELEASE SOLVENT



Dissolves dry mounting tissue glue and is a special releasing solvent used to removed artwork from various mounting adhesives. It can also be used to clean adhesive residue off artwork or mounting press parts. 32 oz. can.

This product only ships Our Truck or common carrier.

Item #	Price Each
972	

MOUNTING GLUE



All Purpose Mounting Adhesive for the Picture Framing and Photographic Industries
 Bonds posters, prints, RC photo and fabrics. Can be applied with roller, brush or used in Potdevin Roll Laminators.
 • Acid Free • Non Toxic • Water Soluble • Non Solvents

SAVE 10%

Item #	Size	Price Each	4 +
610	Gallon		

ALL PURPOSE MOUNTING GLUE



Mount posters, RC photos, prints, fabrics and vinyls to regular or coated board and foamboard with this superior, durable adhesive. It is neutral pH, water soluble, freeze thaw stable and sets up quickly with a 20 minute open time. Apply with a brush or roller for use by hand, cold vacuum press or Potdevin Roll Laminator. 1 gallon.

SAVE 15%

Item #	Price Each	4 +
980		

VACUUM MOUNTING ADHESIVE

Bonds paper or fabrics to wood, masonite, foamboard and cardboard. Acid-free, non-toxic, no solvents, water reversible, cleans up with water. Works on posters, prints, RC photos and fabrics. Economical and easy-to-use. No mixing needed. Apply directly from the container. It is pH neutral and water reversible. Can be used with any regular or coated mounting stock.



SAVE 10%

Item #	Size	Price Each	4 +
3649	Gallon		

FABRIC ADHESIVE



This special glue is made to mount fabrics on matboard, liners, chipboard, MDF, etc. Apply with a brush or paint roller to an even coat, place material down and flatten. Can be used with linen, burlap, velvet, velveteen, canvas, polyester and so much more. Water resistant when dry, water soluble and can be heat reactivated.

Item #	Size	Price Each
1340	Gallon	

SCOTCH™ PRO Hot Melt GLUE APPLICATOR



New high volume, high productivity industrial tool. Self-contained applicator, anti-tip guard, built-in stand, contoured grip, wide trigger and high volume adhesive delivery. Perfect for your frame shop. Glue Sticks: 1/2"x10". 1 lb=appx. 12 glue sticks.

Item #	Description	Price Ea	
769	AEII Glue Applicator		
Item #	Description	Price/lb *	5 lbs. *
770	3M Hot Melt		

PERMA-JOIN FRAMERS WOOD GLUE™



Guaranteed strongest bond wood glue. Dries clear. Water soluble. Formulated exclusively for the Framing Industry.

SAVE 10%

Item #	Price Each	4 +
GP <input checked="" type="checkbox"/>		
GG		

#GP Pint (16 oz.) Comes with resealable squeeze spout

DECOR POLYBONDS

A stronger bonding glue specifically formulated for polystyrene mouldings. Dries clear. Easy-to-use. Sets up quickly. Control drop applicator. Convenient twist off cap. 2 oz. bottle.

EVERYDAY LOW PRICE
STRONGEST BOND



NEW LOWER PRICES!

Item #	Size	Price
989	2 oz.	
990	4 oz.	

#989 2 oz. #990 4 oz.

POLYSTYRENE GLUE



Fast curing solvent cement for joining styrene moulding.
 1 Pint (16 oz.) 0.473 liter

SAVE 10%

Item #	Price Each	4 +
311 <input checked="" type="checkbox"/>		

GE SILICONE SEAL



GE Silicone Seal is the ideal material for Paper Tole projects and is a general purpose adhesive for crafts. It is particularly useful for joining hard materials such as glass, ceramic, metal, plastics and wood. Dries clear. Skims over in 10 minutes, dries to the touch in 1 hour, and is fully cured in 24 hours. 2.8 fl. oz.

SAVE 10%

Item #	Price Each	12 +
1515 <input checked="" type="checkbox"/>		

See back cover for details

Eff. 2/18/23

COTTON GLOVES: 12 pairs/24 gloves

Use these fine cotton gloves to avoid fingerprints. Used for handling mats, artwork, prints, negatives and microfilm, where body oils, grease and dirt could cause major damage. One size fits all. One dozen pairs/pkg.

Item # 656



ANTI-STATIC GLOVES

A remarkable blend of soft conductive and synthetic fibers. The conductive gloves suppress dust collecting electrostatic charges when handling delicate and sensitive static prone materials. When soiled, the gloves may be washed with a gentle soap or detergent and tumble-dried at the 'warm' setting. Size: Large

Item # 1395

ANTI-STATIC TIGER CLOTH



10" x 18" anti-static, microfiber cloth that dissipates static charges. Hundreds of thousands of small pockets in the microfiber cloth aggressively capture the dust and dirt from glass. Packaged in a zip lock bag.

Item # 1394

ANTI-STATIC PANTHER CLOTH



Specifically engineered for cleaning with liquids and solutions. The 10" x 18" black cloth dissipates or drains off static charges. It is not wet or "soggy" and exposure to air won't dry it out. Packaged in a zip lock bag.

Item # 1560

LINTLESS WIPING CLOTHS

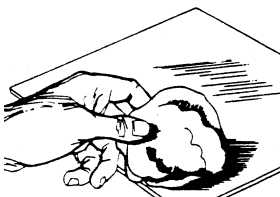

New material. Assorted overall sizes. Ideal for cleaning glass, etc. Machine washable and reusable. Cheaper and better than paper towels. Imported. (1lb. pack) **DECOR** Exclusive
Item #648

DECOR SUPER PLUS MAT SAVERS

Great for matboards, wood and metal mouldings

Correct mat "GOOFS" due to dull blades or incorrect blade depth adjustment. Works on wood/metal moulding mistakes quickly and easily.
25/pkg. 6 3/4" L x 3 1/4" W
Item # 997 1 pkg

BURNISHING BONES

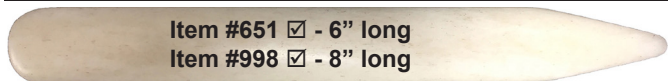

Item #651 - 6" long
Item #998 - 8" long

Tool of the trade removes rough mat edges caused by knife cuts. Makes overcuts less obvious leaving a smooth fine mat cut finish. It is especially useful for insuring tight secure bond of our tapes to porous paper surfaces.

DUSTING BRUSH



Removes dust and lint from mats, glass and pictures before fitting. Made of 2 1/2" natural horse hair bristles. Overall size is 15 1/2" with 9" being bristle.
Item # 655

ANTI-STATIC BRUSH - 4"



The unique blend of soft natural hairs and conductive synthetic fibers plus the conductive nature of the construction result in effective static dissipation. Dust and lint are whisked away. Complete with carrying case.

Item # 1392

ANTI-STATIC SOFT BRUSH - 5-1/2"



Eliminate reframing due to dust spots and lint. There is a new professional tool for picture frames that removes static and dust from glass, acrylic, plexi, plastic, matboards, photos, print and art work. The unique blend of soft natural hairs and conductive synthetic fibers plus the conductive nature of the construction result in effective static dissipation.
Item # 1393 - \$39.59

DRY CLEANING PAD



3 oz. Pads

Item #	Price	12 +
646	<input checked="" type="checkbox"/>	

Gently cleans mistakes, smudges and smears from mats, artwork, linen liners and documents. Pads contain super soft grit-free powder. Twist pad lightly to release powder. Then rub on soiled area. Very easy to use and long lasting. Never needs washing.

1/8" Thick RUBBER ROLLERS

Multi-purpose 4" and 8" wide rubber rollers. Ideal for burnishing photos, mounting block printing, stenciling, rubber stamping and more. Plated steel wire handle. Smooth rolling action. Handle locked in center. 1" diameter wood center with end caps.



Item #	Width	Price
1443 <input checked="" type="checkbox"/>	4"	
1444 <input checked="" type="checkbox"/>	8"	

PICTURE FRAME TOUCH-UP KIT from Chartpak

Great for touching-up fine wooden frames. Cover join lines on new frames and chips and scratches on old. These markers are specially formulated to blend with the most popular wood tones. The Tri-Nib system gives you fine, medium and broad strokes. Great for touching-up wooden craft and hobby projects too!

The Chartpak Picture Frame Touch-up Kit is available as a 9 color set in a handy reusable vinyl pouch, or a set of 25 stored in our plastic marker caddy.



#518
Set of 9 Markers
contains * items



#519
Set of 25 Markers
with blender.

Item #	Description	Price
518 <input checked="" type="checkbox"/>	Set of 9 markers with * items in pouch (no Blender)	
519 <input checked="" type="checkbox"/>	Complete set of 25 includes storage bin (with Blender + 2 Blacks)	
520-542, 1397 <input checked="" type="checkbox"/>	Individual markers (see below)	

Item	Color	Item	Color	Item	Color
520 <input checked="" type="checkbox"/>	Blender	521 <input checked="" type="checkbox"/>	Black	522 <input checked="" type="checkbox"/>	Light Oak *
523 <input checked="" type="checkbox"/>	Medium Oak *	524 <input checked="" type="checkbox"/>	Dark Oak *	525 <input checked="" type="checkbox"/>	Red Mahogany *
526 <input checked="" type="checkbox"/>	Light Pine *	527 <input checked="" type="checkbox"/>	Medium Cherry *	528 <input checked="" type="checkbox"/>	Dark Cherry *
529 <input checked="" type="checkbox"/>	Walnut/Mahogany *	530 <input checked="" type="checkbox"/>	Dark Walnut *	531 <input checked="" type="checkbox"/>	Cadmium Yellow
533 <input checked="" type="checkbox"/>	UltraMarine	535 <input checked="" type="checkbox"/>	True Blue	536 <input checked="" type="checkbox"/>	Ice Blue
540 <input checked="" type="checkbox"/>	Evergreen	541 <input checked="" type="checkbox"/>	Leaf Green	542 <input checked="" type="checkbox"/>	Grass Green
1397 <input checked="" type="checkbox"/>	Basic Grey #5				

RUB 'N BUFF

Lustrous wax base metallic finishes for antiquing. Just rub on any surface with finger or soft cloth then gently buff to a luster. **1/2 oz. tube**



MIX 'N MATCH for QUANTITY PRICES

Item #	Description	Price	6 +
76-1 <input checked="" type="checkbox"/>	Gold Leaf		
76-2 <input checked="" type="checkbox"/>	Antique Gold		
76-3 <input checked="" type="checkbox"/>	Grecian		
76-4 <input checked="" type="checkbox"/>	Ebony		
76-5 <input checked="" type="checkbox"/>	Silver Leaf		
76-6 <input checked="" type="checkbox"/>	Spanish Copper		
76-8 <input checked="" type="checkbox"/>	Autumn Gold		
76-12 <input checked="" type="checkbox"/>	Euro Gold		
76-13 <input checked="" type="checkbox"/>	Pewter		

SHOP APRON



Item # 647
19 1/2" x 24" - heavy duty apron designed for Picture Framers. Fully washable. Adjustable neck and tie strap. Three full pockets at bottom with pencil pocket in middle. Denim - 10 oz.

NAIL HOLE FILLERS



- For Wood Frames
- A pliable filler for cracks, crevices and nail holes.
- Will Not Shrink or Dry Out



Item #	Description	Price	Item #	Description	Price
2 oz. TINS			1 lb. JARS		
21-1 <input checked="" type="checkbox"/>	Dark Gold		22-2 <input checked="" type="checkbox"/>	Gold	
21-2 <input checked="" type="checkbox"/>	Gold		22-3 <input checked="" type="checkbox"/>	Black	
21-3 <input checked="" type="checkbox"/>	Black		22-5 <input checked="" type="checkbox"/>	White	
21-4 <input checked="" type="checkbox"/>	Walnut				
21-5 <input checked="" type="checkbox"/>	White				
21-6 <input checked="" type="checkbox"/>	Natural				
21-7 <input checked="" type="checkbox"/>	Silver				
21-15 <input checked="" type="checkbox"/>	Ivory				
21-20 <input checked="" type="checkbox"/>	Dark Walnut				
21-22 <input checked="" type="checkbox"/>	Gray				

WOODSTAIN DAUBERS



Handy applicators of stains is used for small jobs for touching up knicks and scratches on frames. The felt tip applicator is great for use on fresh cut moulding corners before joining to eliminate the look of raw wood showing at joints. 2 oz. bottles contain enough stain for hundreds of frames.

MIX 'N MATCH for QUANTITY PRICES **SAVE 10%**

Item #	Description	Price	12 +
23-1 <input checked="" type="checkbox"/>	Black		
23-2 <input checked="" type="checkbox"/>	Walnut		
23-4 <input checked="" type="checkbox"/>	Spanish Walnut		
23-7 <input checked="" type="checkbox"/>	Cherry		
23-8 <input checked="" type="checkbox"/>	Mahogany		
23-9 <input checked="" type="checkbox"/>	Golden Oak		

BRUSH 'N LEAF



Decorate, stripe, or highlight with genuine metallic leafing in one brush-on step. Leaves beautifully on any surface, any material. **1 oz. jars**

MIX 'N MATCH for QUANTITY PRICES

Item #	Description	Price	6 +
20-1 <input checked="" type="checkbox"/>	Gold Leaf		
20-2 <input checked="" type="checkbox"/>	Antique Gold Leaf		
20-3 <input checked="" type="checkbox"/>	Silver Leaf		



GILT CREAM



- Easy-to-use.
- 6 beautiful and attractive colors.
- Colors are intermixable.
- Ideal for retouching damaged frames and giltwork.
- Apply to the surface with a cotton cloth or small brush for intricate areas.

- Allow to dry for a minimum of four hours, longer if possible, and either leave matte or buff to a shine.
- For a better finish we recommend applying several thin coats of Gilt Cream as opposed to one thick coat.
- Gilt Cream can be revived or thinned with turpentine or good quality white spirit.
- Clean tools in white spirit.
- 30ml jars.

Item #	Description	Price
1372 <input checked="" type="checkbox"/>	Chantilly (19th Century Gold)	
1373 <input checked="" type="checkbox"/>	Compiegne (Modern Gold)	
1374 <input checked="" type="checkbox"/>	Rambouillet (Bronze)	
1375 <input checked="" type="checkbox"/>	St. Germain (Silver)	
1376 <input checked="" type="checkbox"/>	Trianon (Traditional Gold)	
1377 <input checked="" type="checkbox"/>	Versailles (Red Base Gold)	
1447 <input checked="" type="checkbox"/>	Set of 8 jars: (2) Chantilly, (2) Trianon, (1) Versailles, (1) St. Germain, (1) Compeigne, and (1) Rambouillet gilt creams.	

RETOUCH CRAYONS



- Set of 10 wax crayons in assorted colors.
- For filling and masking superficial scratches on finished wooden surfaces and furniture, such as nail holes.
- Applies with an easy rub on and buff off application.
- Rub the crayon across the scratch until it is filled, allow to harden then buff off the excess with a cotton

cloth.

Item #	Description	Price
1352 <input checked="" type="checkbox"/>	Retouch Crayons-set of 10	

GILT FILLER STICKS



- Pure wax sticks.
- 6 attractive and functional colors.
- Used to replace small missing parts like beading and for filling nail holes and mitre joint gaps.
- Formulated for repairing finished surfaces without damage.
- Fill small-to-medium holes, cracks and scratches without sanding or having to strip the finish.

- Apply without a heat source and lack of shrinkage make them ideal for use on finished furniture and other articles.
- Colors are intermixable.

Item #	Description	Price
1354 <input checked="" type="checkbox"/>	Chantilly (19th Century Gold)	
1355 <input checked="" type="checkbox"/>	Compiegne (Modern Gold)	
1356 <input checked="" type="checkbox"/>	Rambouillet (Bronze)	
1357 <input checked="" type="checkbox"/>	St. Germain (Silver)	
1358 <input checked="" type="checkbox"/>	Trianon (Traditional Gold)	
1359 <input checked="" type="checkbox"/>	Versailles (Red Base Gold)	

WAX FILLER STICKS



- Wax sticks containing beeswax, resins and earth pigments.
- 11 attractive and beautiful colors.
- Used to repair cracks, splits and small-to medium sized holes without sanding or having to strip the finish.
- Can be applied without a heat source.
- Ideal for use on finished furniture and other articles.
- Dry quickly.
- Have no shrinkage.
- Colors are intermixable.

Item #	Color	Price	Item #	Color	Price
1360 <input checked="" type="checkbox"/>	Dark Cherry		1366 <input checked="" type="checkbox"/>	Light Mahogany	
1361 <input checked="" type="checkbox"/>	Dark Mahog		1367 <input checked="" type="checkbox"/>	Light Oak	
1362 <input checked="" type="checkbox"/>	Dark Oak		1368 <input checked="" type="checkbox"/>	Med Oak	
1363 <input checked="" type="checkbox"/>	Dark Walnut		1369 <input checked="" type="checkbox"/>	Med Walnut	
1364 <input checked="" type="checkbox"/>	Ebony		1370 <input checked="" type="checkbox"/>	White	
1365 <input checked="" type="checkbox"/>	Ivory				



and



BLACK BISON FINE PASTE WAX

• Gives good resistance to



150ml cans

- finger and water marks
- Ideal for small surfaces
- Protects wood frames
- Highly lustrous and hard wearing
- Helps cover marks and scratches
- Drying time: minimum 20 minutes
- Endorsed by the Guild of Master Craftsmen
- Silicone Free

Item #	Description	Price
1378 <input checked="" type="checkbox"/>	Antique Pine	
1379 <input checked="" type="checkbox"/>	Georgian Mahogany (Dark Brown)	
1380 <input checked="" type="checkbox"/>	Medium Oak	
1381 <input checked="" type="checkbox"/>	Neutral	

SEPP IMITATION LEAF



Imitation Gold or Silver Leaf is 5 1/2" x 5 1/2" square. A book contains 25 leaves that covers a surface area of approximately 5 1/4 square feet without waste or overlap. You can determine the percentage of waste based on the complexity of the object and expertise level. If, for

Item #	Package	Price
1351 <input checked="" type="checkbox"/>	Gold - Book of 25 leaves	
1371 <input checked="" type="checkbox"/>	Silver - Book of 25 leaves	

ROTTENSTONE



Finely ground, decomposed limestone used for polishing metals and distressing water gilded surfaces to reveal bole and lay lines. Gray color makes it a desirable antiquing dust.

Simply dust over areas needing Rottenstone. Can also be mixed in the Neutral Black Bison Fine Paste Wax (#1381) and then applied to frame.

Item #	Description	Price
1383 <input checked="" type="checkbox"/>	Rottenstone - 5oz jar	\$12.59 ea.

BLACK PATINATING WAX

Achieve a true, deep jet black finish or patina with this specialty wax. Ideal for antiquing frames that are bright and obtaining an aged finish on wood and metal frames. Ideal on raw wood with a hard grain, like oak. Suitable for use on wood, metal, gilt, plaster, MDF and papier-mâché.



Example of black patinating

Item #	Description	Price
1382 <input checked="" type="checkbox"/>	Black Patinating Wax - 250ml tin	

KNEADED ERASER

Excellent for removing or highlighting chalks, pencil, charcoals and pastels. Kneads into any shape, removes marks cleanly, leaves surfaces smooth and bright. Large size, block shape, Individually wrapped, one dozen in a box.

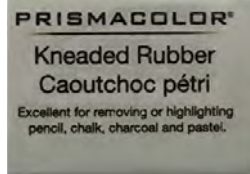

Item #	1 box
1419 <input checked="" type="checkbox"/>	

SHARPIE FINE POINT MARKERS



Great for drawing french lines and touching up frames. Quick drying water resistant ink.

SAVE 10%

Item #	Color	1	12/style @
1420 <input checked="" type="checkbox"/>	Black		

PILOT METALLIC MARKERS

Super color markers



Marks and stays permanently on glass, plastic, marble, photos - just about everything!

Item #	Desc.	Color	1
1437 <input checked="" type="checkbox"/>	Extra Fine Point	Gold	
1438 <input checked="" type="checkbox"/>	Extra Fine Point	Silver	
1439 <input checked="" type="checkbox"/>	Medium Point	Gold	
1440 <input checked="" type="checkbox"/>	Medium Point	Silver	

PILOT BROAD TIP MARKER



Marks permanently on wood, plastic, metal, and glass. Waterproof and dries instantly. Features a three-way nib for versatility. Snap-tite cap. Comfort grip barrel design. Extra large ink supply.

Item #	Color	Price
1441 <input checked="" type="checkbox"/>	Black	

EASEL BACKS and More ...

BLACK VELOUR EASEL BACKS

- Stands vertical or horizontal
- Finest quality genuine velour
- Sturdy construction .080" thick easel back and .120" thick stand
- Can be trimmed



Item #	Size	Price 6 pack	SAVE 15% 3+ pkgs	SAVE 25% 6+ pkgs
848 <input checked="" type="checkbox"/>	4x6			
849 <input checked="" type="checkbox"/>	5x7			
850 <input checked="" type="checkbox"/>	6x8			
851 <input checked="" type="checkbox"/>	8x10			
Includes ribbon:				
852 <input checked="" type="checkbox"/>	10x12			
853 <input checked="" type="checkbox"/>	11x14			
Includes vertical & horizontal hanger and ribbon:				

Item #	Size	Price Each	SAVE 15% 6+/item
854 <input checked="" type="checkbox"/>	14x18		
855 <input checked="" type="checkbox"/>	16x20		

Larger Quantity Discounts Available

PREMIUM BLACK FAUX LEATHER EASEL BACKS

- Stands vertical or horizontal
- Sturdy construction .080" thick easel back and .120" thick stand
- Can be trimmed

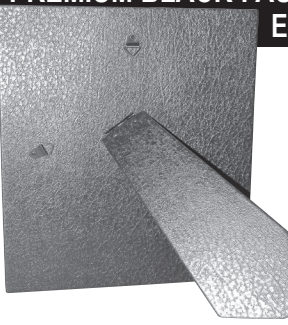

Item #	Size	Price 6 pack	SAVE 15% 3+ pkgs	SAVE 25% 6+ pkgs
Includes 1 Vertical Hanger:				
856 <input checked="" type="checkbox"/>	3 1/2 x 5			
857 <input checked="" type="checkbox"/>	4x6			
858 <input checked="" type="checkbox"/>	5x7			
859 <input checked="" type="checkbox"/>	6x8			
Includes 1 Vertical/1 Horizontal Hanger:				
860 <input checked="" type="checkbox"/>	8x10			
933 <input checked="" type="checkbox"/>	8 1/2 x 11			
Includes 1 Vertical/1 Horizontal Hanger + Ribbon:				
861 <input checked="" type="checkbox"/>	10x12			
862 <input checked="" type="checkbox"/>	11x14			

Larger Quantity Discounts Available

BLACK VELOUR DOOR BACK EASELS

- Stands vertical or horizontal
- Finest quality genuine velour
- Sturdy construction .080" thick easel back and .120" thick stand
- Can be trimmed
- Great for high-end projects and gift frames.

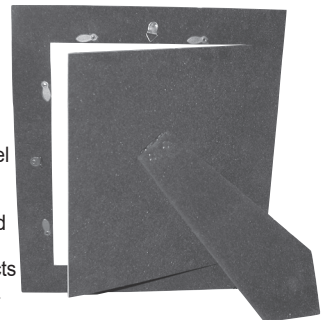

Item #	Door Size	Outer Size	Price 6 pack	SAVE 15% 3+ pkgs	SAVE 25% 6+ pkgs
Includes 2 turnbuttons, 2 hangers:					
863 <input checked="" type="checkbox"/>	4x6	5 1/2 x 7 1/2			
Includes 4 turnbuttons, 2 hangers:					
864 <input checked="" type="checkbox"/>	5x7	6 1/2 x 8 1/2			
Includes 6 turnbuttons, 2 hangers + ribbon:					
865 <input checked="" type="checkbox"/>	8x10	11x13			
Includes 7 turnbuttons, 3 hangers + ribbon:					
866 <input checked="" type="checkbox"/>	11x14	14x17			

Larger Quantity Discounts Available

TURNBUTTONS

Item Type Color Size Qty Price 10+ boxes



918 Ridge Black 13/16" 100
includes 1/2" x #4 Flat Head Wood Screws.



913 Flat Black 13/16" 100
includes 3/8" x #4 Black Pan Head Wood Screws



712 Ridge Silver 13/16" 100
includes 1/2" x #4 Flat Head Wood Screws (#436 - see page 30).



713 Ridge Silver 1" 100
includes 1/2" x #4 Flat Head Wood Screws (#436 - see page 30).

All turnbuttons shown appx size.

PLASTIC CHANNELS for Easel Backs

Quickly and easily produce standing photo frames with any moulding. Can be positioned with ATG tape and/or stapled. 3 ft. long sticks. 1 1/16" wide with 1/4" lip. Cuts easily and can ship UPS.

Price per 3-foot stick
SAVE 10% SAVE 15% SAVE 25%

Item	Min. 10	25+	50+	100+
767 <input checked="" type="checkbox"/>				

Makes any frame into a standing photo frame

EaselMate™ by Fletcher



Designed to replace the standard cardboard easel backs. Fits both wood and metal frames, handles up to 11" x 14" size, installs in seconds, and adjusts to any angle. Easily removable, extremely sturdy, very economical, and will not collapse.

Item #	Qty	Price	Item #	Qty	Price
F09300 <input checked="" type="checkbox"/>	2/pkg-retail		F09303 <input checked="" type="checkbox"/>	48 bulk	
F09301 <input checked="" type="checkbox"/>	12 bulk		F09304 <input checked="" type="checkbox"/>	100 bulk	
F09302 <input checked="" type="checkbox"/>	24 bulk				

Easel Backs- Self-Stick, Single Wing

Self-Stick Easel Backs are attractive, sturdy, and easy to use. Simply peel and stick for professional looking signs and displays. Also a great way to temporarily display your favorite photographs. Available in both black and white.

Item #	Size	Color	Pack	Price
L3281233 <input checked="" type="checkbox"/>	3"	White	25	
L3283333 <input checked="" type="checkbox"/>	3"	Black	25	
L3281234 <input checked="" type="checkbox"/>	5"	White	25	
L3281234B <input checked="" type="checkbox"/>	5"	White	500	
L3283334 <input checked="" type="checkbox"/>	5"	Black	25	
L3281230 <input checked="" type="checkbox"/>	7"	White	25	
L3281230B <input checked="" type="checkbox"/>	7"	White	500	
L3283330 <input checked="" type="checkbox"/>	7"	Black	25	
L3281231 <input checked="" type="checkbox"/>	9"	White	25	
L3281231B <input checked="" type="checkbox"/>	9"	White	500	
L3283331 <input checked="" type="checkbox"/>	9"	Black	25	
L3281232 <input checked="" type="checkbox"/>	12"	White	25	
L3283332 <input checked="" type="checkbox"/>	12"	Black	25	
L3281235 <input checked="" type="checkbox"/>	15"	White	25	
L3283335 <input checked="" type="checkbox"/>	15"	Black	25	



LINCO

Easel Backs- Self-Stick, Double Wing

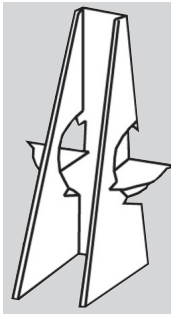

Easy to use and sturdy like the single wing versions to the left. The double wing construction gives increased stability to tall, heavy items.

Item #	Size	Color	Pack	Price
L3281236 <input checked="" type="checkbox"/>	7"	White	25	
L3281237 <input checked="" type="checkbox"/>	9"	White	25	
L3281238 <input checked="" type="checkbox"/>	12"	White	25	

See back cover for details

Eff. 3/8/23

3M BUMPONS™

Adhesive Backed
Protective Products



No holes to drill or screws needed. Simply remove the protective liner and place into position. Helps keep picture level. Resilient, non-marring feature will not rot or dry out. Made with strong high tack pressure sensitive adhesive with an easy release liner.

Style #	Use	Description - 1,000/case	1 Case
907	<input checked="" type="checkbox"/> Wood	3M Bumpon™ 1/2" Clear Round	
908	<input checked="" type="checkbox"/> Wood	3M Bump on™ 1/2" Black Round	
912	<input checked="" type="checkbox"/> Metal	3M Bumpon™ 7/16" Clear Round	

DECOR Protective Rubber Bumpers

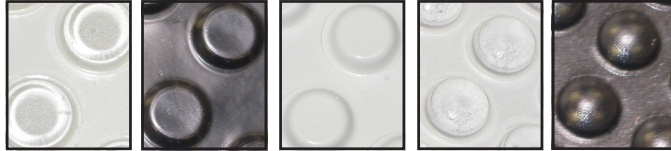

#604 #605 #606 #608 #609

DECOR BUMP-ITS™

For the finishing touch to all professional jobs.

- Self stick silicone rubber bump-its protect wall surfaces from nicks, scratches, slippage and noise without scuffing.
- 1,000/bag **Mix 'N Match for Quantity Prices** **SAVE 10%**

Style #	Use	Description - 1,000/case	1 Bag	5 Bags
604	<input checked="" type="checkbox"/> Wood	1/2" Clear Round BUMP-ITS		
605	<input checked="" type="checkbox"/> Wood	1/2" Black Round BUMP-ITS		
606	<input checked="" type="checkbox"/> Wood	1/2" White Round BUMP-ITS		
608	<input checked="" type="checkbox"/> Metal	1/2" Clear Hemisphere BUMP-ITS		
609	<input checked="" type="checkbox"/> Metal	1/2" Black Hemisphere BUMP-ITS		

CARDBOARD CORNERS

Protect your framed pieces from damage. Your customers will appreciate them. Made of durable 200 lb. test, white cardboard.



Item #	Description	20+ cost/sheet	50+ cost/corner	100+ cost/sheet	200+ cost/corner	400+ cost/sheet
CC	5" x 5" x 1 3/8" depth. 9 corners per sheet		10%	20%	30%	40%
CC-1	4" x 4" x 3/4" depth. 24 corners per sheet					
CC-2	4" x 4" Adjusts to 1/2", 1" & 1 1/2" depths. 16 corners/sh					

DECOR FELT BUMPERS

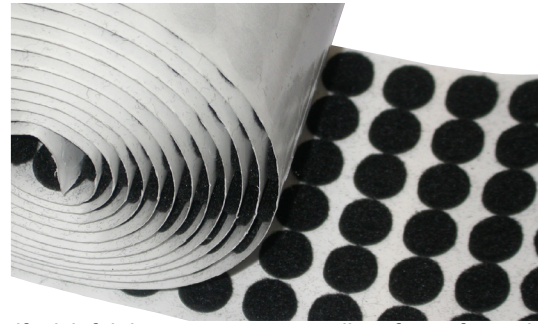

- Self stick felt bumpers protect wall surfaces from nicks, scratches, slippage and noise without scuffing.
- Great for protecting walls, glass, porcelain, ceramics and tabletops.
- 1,000/pkg.

Style #	Description	1 pkg.
845	<input checked="" type="checkbox"/> 1/2" x 1/8" thick Black Felt Bumpers	
846	<input checked="" type="checkbox"/> 1/2" x 1/8" thick Brown Felt Bumpers	

HANG RITE FOAM PADS



- Adhesive on one side which goes on the back of frame.
- Prevents wall damage.
- Made of off-white silicone rubber.
- Helps keep picture straight on wall.
- 1/2" diameter x 3/16" thick

Style #	Qty	1 pkg.	5 pkgs
1333	<input checked="" type="checkbox"/> 100		
1334	<input checked="" type="checkbox"/> 1,000		

NATURAL CORK BUMPERS



- Adhesive on one side which goes on the back of frame.
- Prevents wall damage.
- Made of natural cork.
- Helps keep picture straight on wall.
- 1/2" x 1/8" thick

Style #	Qty	1 pkg.	5 pkgs
1332	<input checked="" type="checkbox"/> 1,000		

CORRUGATED SHEETS



200 lbs Test
for Backing



SAVE 10% SAVE 20% SAVE 30% SAVE 40%
Full Skid

Item #	Size	1-24	25+	50+	100+	250+
1900	32" x 40"					
1902	36" x 48"					
1901	40" x 60"					
1903	48" x 96"					

Please Inquire About Larger Quantity Discounts!

BUFFERMOUNT ACID-FREE REVERSIBLE DRY MOUNTING TISSUE

This is the safest, most versatile mounting tissue available. Coated on both sides, it is reversible, ecologically friendly and features an acid-free adhesive with a very low bonding temperature (160° - 190°).

Item #	Size	Price Each
807 <input checked="" type="checkbox"/>	24.5" x 90'	
808	40.5" x 90'	

RELEASE BOARDS

Made of smooth 1 ply chip board coated with silicone on both sides. These boards are more durable and are reusable & easy to handle & can be used in place of release paper. Protect artwork & keep your mounting press clean.

Item #	Size	Price
270	32" x 40"	
271	40" x 60"	

RELEASE PAPER - Single Sided

Keep your mounting press clean with this reusable silicone treated, protective overlay made of smooth white paper. Best for dry mounting and laminating when there is a potential for adhesive overhang onto the press platen.

Item #	Size	Price Each
974 <input checked="" type="checkbox"/>	42" x 90'	

FINISH GUARD UV OVERLAMINATING FILM



Features ultra-violet protection and will protect the surface of prints, posters, etc. from dust, fingerprints and moisture. A durable and lightweight alternative to glass and acrylic that will safeguard your work for a lifetime. The film adheres directly to the front surface and is non-reversible. These films are pre-pierced to prevent bubbles and come with a carrier paper with grid lines to help in positioning. A bonding point of 200°-225° for 3-5 minutes in a mechanical press and 7-9 minutes for a vacuum press.

Item No. Size Price

Finish Guard Gloss - Smooth even inish

4 mil - sparkling gloss finish that reduces glare & reflection

964 41" x 50'

Finish Guard Satin Matte - Smooth even finish

3 mil - soft, moderately reflective finish that enhances colors while reducing glare

966 41" x 50'

Finish Guard Canvas Texture

5 mil - distinctive canvas-like texture & soft sheen add surface interest

969 41" x 50'

Finish Guard Suede

5 mil - textured finish that reduces glare and produces a soft, suede appearance

971 41" x 50'

1/4" Sponge Overlay Foam for Vacuum Press



For a smooth and even lamination, a sponge overlay is recommended for use in vacuum presses. Can be cut.

Item #	Size	Price Each
691 <input checked="" type="checkbox"/>	50" x 102"	

DRYTAC ARTSHIELD U.V. HEATSET OVERLAMINATING FILMS

These DRYTAC PVC laminating films are extremely versatile and easy to apply and can be used to protect prints, posters and resin coated photographs. These pre-pierced films which come in handy rolls consist of PVC films backed with a low tack adhesive and covered with a release liner. Mounting at 185°F–210°F (85°C–99°C) forms a permanent non-reversible bond. Sponge foam overlay is recommended for consistent finish.

Item No. Size Price

Satin Finish Laminating Film - Pre-pierced

2 mil. - The most popular film giving a pleasing luster finish after heat sealing.

682 41" x 50'

DRYTAC TRIMOUNT DRY MOUNTING TISSUE

Universal and breathable, PREMIUM QUALITY general purpose permanent mounting tissue. (Comparable to Colormount and Techmount)



Item #	Size	Price Each
672 <input checked="" type="checkbox"/>	25.5" x 150'	
673 <input checked="" type="checkbox"/>	25.5" x 300'	
674 <input checked="" type="checkbox"/>	41" x 150'	
675 <input checked="" type="checkbox"/>	41" x 300'	

DECOR

DOUBLE-SIDED SILICONE RELEASE PAPER

A high quality reusable white paper double-sided non-stick silicone coated release paper. Ideal for use as a cover sheet or release folder to protect artwork and to keep your press clean from any overhang or transfer of adhesive.

Mix 'N Match Items #787 thru #805

SAVE 10%

ITEM #	SIZE	PRICE EACH
800 <input checked="" type="checkbox"/>	26" x 60'	
802 <input checked="" type="checkbox"/>	42" x 90'	
803	50" x 105'	

3+

DECOR

DRY MOUNT TISSUE

A Superior Quality Permanent General-Purpose Dry Mount Tissue (Comparable to Trimount, Colormount and Techmount)

This multi-purpose mounting tissue is coated on both sides and is designed for mounting fine art prints, standard prints, RC photographs, lithograph papers, fabrics, watercolor papers, inkjet papers (coated and uncoated) to most types of mounting projects. The pH-neutral 3-mil heat activated adhesive mounts at 190° in 1½ minutes on a mechanical press and 2-3 minutes on a vacuum press.

Mix 'N Match Items #787 thru #805

SAVE 10% SAVE 20%

ITEM #	SIZE	PRICE EACH
787 <input checked="" type="checkbox"/>	24.5" x 150'	
788 <input checked="" type="checkbox"/>	40.5" x 150'	
789 <input checked="" type="checkbox"/>	48.5" x 150'	

3+

6+

FLETCHER Framemaster Point Driver



Easily-and-comfortably fire points flatly into the frame with a minimum amount of pressure due to the full-grip trigger which reduces fatigue. Spring-adjusted firing power to match wood density. Does not double feed or jam. Easy-to-load magazine holds 100 points for reduced down time.



#F08950 and #784 shown approx actual size

Item Description Price

F07500 <input checked="" type="checkbox"/>	Framemaster Point Driver	
F08950 <input checked="" type="checkbox"/>	Framemaster Framers Points 5/8" 3000/box	
784 <input checked="" type="checkbox"/>	Decor Framer's Points 5/8" 3,000/box	
F08980 <input checked="" type="checkbox"/>	Framemaster Glazier Points 3/8" 5000/box	
785 <input checked="" type="checkbox"/>	Decor Glazier's Points 3/8" 5,000/box	

FLETCHER Multimaster Point Driver



Perfect for attaching multiple mouldings, stacked or liner, in the same frame. Easy-to-load magazine holds 167 MultiPoints per stack. Equipped with spring adjustment. To adjust for wood density.

#F08975 shown approx actual size

Uses #F08975 Framers Points.

Item #	Description	Price	6 +
F07800 <input checked="" type="checkbox"/>	Multimaster Point Driver		
F08975 <input checked="" type="checkbox"/>	Multimaster Framers Points 1/2" 3000/box		

FLETCHER Framemate 2-in-1 for Points, Push Points & Brads



Insert points, push pins and brads into wooden frames to hold glass, boards, canvas, etc. The adjustable magnetic anvil holds points and brads in place, while the rubber cushion prevents marring of the moulding. It also trims paper and can be used as a glass break out tool.

Uses #F08911 Framers Points (below).

Item #	Description	Price
F07200 <input checked="" type="checkbox"/>	Framemate (2-in-1 tool)	

FLETCHER Fleximaster Point Driver



Easy-to-load magazine accommodates 170 flexible points. Spring-adjusted firing power to match wood density. Lightweight and full-grip trigger provides comfortable firing of points. Used with Fletcher's flexible points that can be easily bent to change frame contents.

#F08955 and #695 shown approx actual size

Item #	Description	Price
F07700 <input checked="" type="checkbox"/>	Fleximaster Point Driver	
F08955 <input checked="" type="checkbox"/>	Fleximaster Framers Points 5/8" 3700/box	
695 <input checked="" type="checkbox"/>	Decor Flexi Framer's Points 5/8" 4,850/box	

HAND FINISHING TOOLS



#F09515



#F09517



#F09519

PUSHMATE #F09515

Perfect for inserting Fletcher push points, triangle points and diamond points into wood frames and window sashes. Rubberized raised grip provides added comfort and helps prevent damage to the mat and other backing materials. Comes with tube of 40 Glaziers Push Points #F08711 (to right).

PULLMATE #F09517

Specifically designed to remove Fletcher Framer's Points from wood frames. Raised grip helps protect framing materials.

SPRINGMATE #F09519

Inserts and removes metal clips with ease. Slotted tip helps prevent slipping & damage.

Item #	Desc.	Price
F09515 <input checked="" type="checkbox"/>	Pushmate	
F09517 <input checked="" type="checkbox"/>	Pullmate	
F09519 <input checked="" type="checkbox"/>	Springmate	



FLETCHER Framers Points

Framers points designed to work with FrameMate 2-in-1 tool above. Not designed for Fletcher FrameMaster.

Item #	Description	Price
F08911 <input checked="" type="checkbox"/>	Framers Points 200/card	



FLETCHER Glaziers Points

Zinc coated #7 Glazing Points that are "T" shaped and can be inserted into wood frames with a putty knife.

Item #	Description	Price
F08711 <input checked="" type="checkbox"/>	Push Pins 50/card	

FLETCHER #2 Diamond Points



Wax-free diamond points do not leave residue and eliminates jamming. Fits #5 Point Driver (Fletcher #07-111).

Item #	Description	Price
F08211 <input checked="" type="checkbox"/>	#2 Diamond Points-4000/box	

FLETCHER Pneumatic Point Drivers for Professional Volume Assembly

Fires tight and flat to the surface providing superior holding power. Used with Framers Points in stacks of 250 points and Flexible Framer's Points in stacks of 425 points. No "pull-back" required; slide point driver along moulding for continued firing. Ergonomically designed trigger eliminates hand fatigue.

Item #	Description	Price
F07300	Pneumatic Framemaster Point Driver	
F08985 <input checked="" type="checkbox"/>	Framemaster Framers Points 5/8" 12,000/box	
786 <input checked="" type="checkbox"/>	Decor Framer's Points 5/8" 12,000/box	
784 <input checked="" type="checkbox"/>	Decor Framer's Points 5/8" 3,000/box	
F07400	Pneumatic Fleximaster Point Driver	
F08995 <input checked="" type="checkbox"/>	Fleximaster Framers Points 5/8" 12,000/box	
695 <input checked="" type="checkbox"/>	Decor Flexi Framer's Points 5/8" 4,850/box	



DECOR DUAL POINT DRIVER



This PROFESSIONAL GRADE driver quickly inserts rigid or flexible points in the wood or poly rabbet of the frame. Light-weight & full-grip trigger allows for easy-to-use adjustment tension knob for hard woods.

869
 Uses points #637, #638, #650, #985, #986, #994 & #995

LOGAN F500-2 DUAL ELITE POINT DRIVER 43



Quickly drives either rigid or flexible inserts into the rabbet of wood or poly mouldings to properly secure the glass, artwork and backing material into the frame. Features an improved comfort grip and tension knob for harder woods.

Item # 643
 Uses points #985, #994, #986 & #995 and Decor #637, #638 & #650

5/8" DECOR XTREME ULTRA-LOCK POINTS



Item #	Qty	Price ea.	SAVE 10% 3+
RIGID POINTS			
* 637 <input checked="" type="checkbox"/>	2,500		
FLEXI POINTS			
* 638 <input checked="" type="checkbox"/>	2,500		
650 <input checked="" type="checkbox"/>	5,000		

Fits drivers #869, #643 and #373

LOGAN Brand POINTS



Item #	Logan No.	Quan	Price
Rigid Points			
985 <input checked="" type="checkbox"/>	F56	2,500	
994 <input checked="" type="checkbox"/>	F54	600	
Flexi Points			
986 <input checked="" type="checkbox"/>	F55	2,500	
995 <input checked="" type="checkbox"/>	F53	600	

Fits Decor #643 above. 5/8"

DECOR HARD POINT DRIVER



This PROFESSIONAL GRADE driver quickly inserts hard framer's points in the wood or poly rabbet of the frame. Light weight & full-grip trigger allows for easy-to-use adjustment tension knob for hard woods.

868
 Uses points #784.

DECOR POINTS Compatible with Fletcher Style Equipment

Guaranteed to secure backing with great holding power.

Item #	Pkg	Price each	SAVE 7% 5+
Framer's Points 5/8" - 16mm			
784 <input checked="" type="checkbox"/>	3,000/box		
Use in #F07500 Fletcher Framemaster Driver and #F07300 Pneumatic Framemaster Driver, both on pg. 42. Use in #372 below.			
Framer's Points 5/8" - 16mm			
786 <input checked="" type="checkbox"/>	12,000/box		
Use #786 with #F07300 Fletcher Pneumatic Framemaster, pg. 42 and #372 below.			

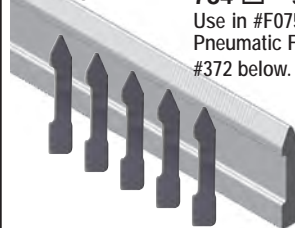

Item #	Pkg	Price each	SAVE 7% 5+
Glazier's Points 3/8" - 9mm			
785 <input checked="" type="checkbox"/>	5,000/box		

LOGAN F500-4 PNEUMATIC DUAL DRIVER

Production level pneumatic point driving tool used in picture framing to secure glazing, mounted art and backing material into wood frame moulding. Requires quick release 1/4" NPT airline and air compressor min. 50 psi. Fast repeat firing for high production framing. Approximately 300 point magazine capacity. Uses Decor Flexi Points #638, #650 #986, #995 or Decor Rigid Points #637, #985, #995.



Item # 1552

DECOR PROFESSIONAL GRADE PNEUMATIC POINT DRIVERS

Designed for high productivity of point insertion into frame backs and photo frames



Dual Point Pneumatic Driver
 Uses Decor Flexi Points #638, #650, #986 & #995 and Decor Rigid Points #637, #985 & #994

Item # 373

- PROFESSIONAL GRADE
- Angled head fires tight and flat to the surface
- Low noise
- Low maintenance
- Ergonomically designed trigger allows for comfortable use.
- Weighs less than 2lbs.

Additional pneumatic drivers on opposite page.



Hard Point Pneumatic Driver
 uses #784 & #786 hard points (above)

Item # 372

F18 BRAD GUN NAILER



The perfect tool for all picture frame backing applications. Provides fast, easy, consistent application of brads without bending.

Item # 640

- All metal construction.
- Easy trigger lever action.
- Stabilizers assure correct entry and depth of penetration.
- Fast front load ability.
- Brads 3/4" - 18mm
- Uses item #642 below
- 50 brad strip capacity.

11/16" BRADS for Gun Nailer above

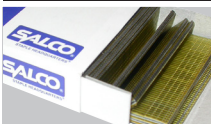

Item #	Pkg. Qty.	Price/pkg
642 <input checked="" type="checkbox"/>	5000/pkg	

Fits F18 Brad Gun Nailer item #640 above.

FLEXI POINTS for Fletcher

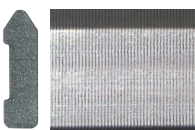

For MANUAL & AIR OPERATED DRIVERS

Black finish flexible framer's points for ALL Fletcher and most makes of flexi point tools. **Decor flexi points have 31% more points per box.** 4,850/pkg (vs 3700/pkg for others). 5/8" long. Use in #F07700 Fletcher Fleximaster and #F07400 Fletcher Pneumatic Fleximaster, (both on pg. 42).

Item #	Size	Price each	5+
695 <input checked="" type="checkbox"/>	5/8" long		

DECOR LONG NOSE PNEUMATIC STAPLER



Item #381

Designed for getting into tight corners and grooves, especially when stretching your customers' canvas art.

- Rapidly loads 200 staples. Uses Decor staples #387 or #388 (below).
- Easy-to-use safety clasp on trigger
- Body made from injected aluminum
- Low maintenance
- A water separator & lubricator are recommended when using air tools
- Weight: 2.2 lbs.

DECOR STAPLES: 3/8" & 1/2"

Most popular 3/8" crown, 22 gauge wire staples used for fitting. Works with Senco, Mastroi, Fasco, Bea and Decor Long Nose pneumatic stapler #381 (above) and other similar style guns.

Item #	Pkg. Qty.	Size	Price/pkg
387 <input checked="" type="checkbox"/>	10,000	3/8" W x 1/2" long	
388 <input checked="" type="checkbox"/>	10,000	3/8" W x 9/16" long	

1/2" crown, 20 gauge wire staples perfect for stretching canvas. Works in Senco, Fasco, Duofast, Bea and Omar guns.

Item #	Pkg. Qty.	Size	Price/pkg
389 <input checked="" type="checkbox"/>	5,000	1/2" W x 3/8" long	

DECOR CARTRIDGES for Cassese

275 nails/cartridge • 6 cartridges/box • 1650 nails/box

Manufactured to the highest standard for smooth operation, tight corners. No jamming. Color coded by size.

MIX 'N MATCH

ALL CASSESE CARTRIDGES for QUANTITY PRICES!

Item #	Size	Wood Type	Cassese Color	Decor Color	Price	SAVE 8%	SAVE 15%
						3+ bxs	10+ bxs
776 <input checked="" type="checkbox"/>	1/4"-7mm	Soft	Pink	Yellow			
777 <input checked="" type="checkbox"/>	1/4"-7mm	Hard	Pink	Yellow			
778 <input checked="" type="checkbox"/>	3/8"-10mm	Soft	Lt. Blue	Green			
779 <input checked="" type="checkbox"/>	3/8"-10mm	Hard	Lt. Blue	Green			
780 <input checked="" type="checkbox"/>	1/2"-12mm	Soft	Dk. Blue	Red			
781 <input checked="" type="checkbox"/>	1/2"-12mm	Hard	Dk. Blue	Red			
782 <input checked="" type="checkbox"/>	5/8"-15mm	Soft	White	Black			
783 <input checked="" type="checkbox"/>	5/8"-15mm	Hard	White	Black			

DECOR V-NAILS



20% More Nails

Other brands have 5,000 per box, We offer 6,000 per box

MIX 'N MATCH ALL Decor V-NAILS for QUANTITY PRICES

Save 8% Save 15%

Item # Size Price/box 3 boxes 10 box
For PISTORIUS, INMES, CASSESE*, Euro, Gielle & Morso

612 (SW to Med)	<input checked="" type="checkbox"/>	1/4"/7mm		
613 (SW to Med)	<input checked="" type="checkbox"/>	3/8"/10mm		
614 (SW to Med)	<input checked="" type="checkbox"/>	1/2"/12mm		
615 (SW to Med)	<input checked="" type="checkbox"/>	5/8"/15mm		
616 (hard & MDF)	<input checked="" type="checkbox"/>	3/8"/10mm		
624 (hard & MDF)	<input checked="" type="checkbox"/>	1/4"/7mm		
625 (hard & MDF)	<input checked="" type="checkbox"/>	1/2"/12mm		
627 (hard & MDF)	<input checked="" type="checkbox"/>	5/8"/15mm		

* Compatible with Cassese cartridges. Cartridges not included. Refill & Reuse your Cassese Cartridges to save money.

For AMP, Alfamacchine & Putnam

617 (SW to Med)	<input checked="" type="checkbox"/>	1/4"/7mm		
618 (SW to Med)	<input checked="" type="checkbox"/>	3/8"/10mm		
619 (SW to Med)	<input checked="" type="checkbox"/>	1/2"/12mm		
620 (SW to Med)	<input checked="" type="checkbox"/>	5/8"/15mm		
621 (hard & MDF)	<input checked="" type="checkbox"/>	3/8"/10mm		
622 (hard & MDF)	<input checked="" type="checkbox"/>	1/4"/7mm		
623 (hard & MDF)	<input checked="" type="checkbox"/>	1/2"/12mm		
626 (hard & MDF)	<input checked="" type="checkbox"/>	5/8"/15mm		

Note: Pistorius & Putnam/AMP Corner nails install in machine with adhesive band up.

TW AMP

Brand V-NAILS by Fletcher/AMP

These Mitre-Mite V-Nails can be used with soft, medium and hard woods.



Item #	Size	Wood Type	Box Qty.	Price
F08334 <input checked="" type="checkbox"/>	1/4"-7mm	HDF*	3,200	
F08335 <input checked="" type="checkbox"/>	1/4"-7mm	Med/Hard	4,000	
F08337 <input checked="" type="checkbox"/>	1/4"-7mm	Soft	4,000	
F08339 <input checked="" type="checkbox"/>	3/8"-10mm	HDF*	2,400	
F08340 <input checked="" type="checkbox"/>	3/8"-10mm	Med/Hard	3,000	
F08342 <input checked="" type="checkbox"/>	3/8"-10mm	Soft	3,000	
F08344 <input checked="" type="checkbox"/>	1/2"-12mm	HDF*	2,400	
F08345 <input checked="" type="checkbox"/>	1/2"-12mm	Med/Hard	3,000	
F08347 <input checked="" type="checkbox"/>	1/2"-12mm	Soft	3,000	
F08349 <input checked="" type="checkbox"/>	5/8"-15mm	HDF*	1,600	
F08350 <input checked="" type="checkbox"/>	5/8"-15mm	Med/Hard	2,000	
F08352 <input checked="" type="checkbox"/>	5/8"-15mm	Soft	2,000	

*HDF or MDF and very hard wood mouldings

#U200

formerly **A2M200 MANUAL V-NAILER**

- Long stroke for moulding up to 7" wide
- Lightweight design & heavy-duty mechanical components
- Choice of front or rear operation
- "Positive Placement" clamping
- Tiltbase
- Unique V-Nail driver assembly system eliminates frequent driver changing and allows for years of trouble-free operation.

15"W x 24"D x 46"H / Wt 83 lbs.
POWER SOURCE: Manual
MOULDING SPECS: Width 1/4"-7" / Height 1/4"-3 3/8"
V-NAIL SIZES: 3, 5, 7, 10, 12, 15 mm

ACCESSORIES: Metal extension arms, custom fences for 6 / 8 sided frames
WARRANTY: 2 yr mfr's / 1 yr wearables
Item #U200 Manual V-Nailer *call*
Item #F04048 Metal Ext. Arms *call*



#U300

formerly **MINIGRAF 3 (VN 2+1) PNEUMATIC V-NAILER**

- Compact-built for many years of trouble-free operation
- Frame is moved across the nail head after setting the front and back stops for V-nail insertion.
- V-nails can be driven or stacked
- Pneumatic load / feed system eliminates jams
- Damage-free joints w/"soft clamp" pneumatics
- "Quick change" hold down to fit most profiles

12" W x 19" D x 14" H / Wt 75 lbs.
POWER SOURCE: Pneumatic
MOULDING SPECS: Width 3/8"-5" / Height 1/4"-5 1/4"
V-NAIL SIZES: 3, 5, 7, 10, 12, 15 mm

ACCESSORIES: Floorstand, wood support table, metal extension arms, custom fences for 6 / 8 sided frames
WARRANTY: 2 yr mfr's / 1 yr wearables
Item #U300 Pneumatic V-Nailer *call*
Item #F04047 Floor Stand *call*
Item #F04046 Table Support Brackets (set of 6) *call*
Item #F04076 Wood Support Table *call*
Item #F04032 Metal Extension Arms *call*

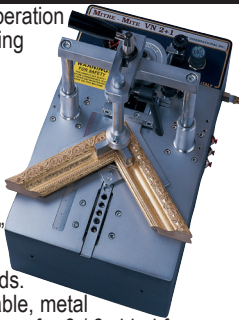

V-Nail Replacement Heads for AMP V-Nailers: U200 and U300

#F04090 3mm	#F04091 7mm	#F04093 12mm
#F04095 5mm	#F04092 10mm	#F04094 15mm

#U400

formerly **VN144S PNEUMATIC V-NAILER**

- Interchangeable V-Nail channels allow operator to quickly change V-Nails
- Drive or stack v-nails accurately anywhere along the frame joint with the user-friendly control arm for left or right operation.
- "Positive Placement" clamping
- Choice of front or rear operation

15 3/4" W x 22 5/8" D x 7 1/2" H / Wt 115 lbs.
POWER SOURCE: Pneumatic
MOULDING SPECS: Width 3/8" - 8" Height 1/4" - 4 3/8"

V-NAIL SIZES: 3, 5, 7, 10, 12, 15 mm
Incl 7, 10 & 12 mm V-Nail channels

ACCESSORIES: Metal extension arms
WARRANTY: 2 yr mfr's / 1 yr wearables
Item #U400 Pneumatic V-Nailer w/floorstand *call*
Item #F04037 Metal Extension Arms *call*



#U500 / #U600

formerly **VN4MP/VN4MC Single/Multichannel V-Nailer**

- Highest level of flexibility by incorporating 5 distinct V-Nail channels that hold 5 different V-Nail sizes (5, 7, 10, 12, 15 mm)
- Operator can insert and stack any of these sizes at up to 10 different positions along the frame joint
- Stores up to **5,000** moulding profiles with easy recall.
- Facilitates the perfect joining solution especially for wide moulding with variability in height
- Joins all types of wood, plastic and MDF/HDF materials

29" W x 29" D x 57" H / Wt 309 lbs.
POWER SOURCE: Electronic, Pneumatic
MOULDING SPECS: Width 3/8"-6 1/4" Height 1/4"-5 1/4"

V-NAIL SIZES: 5, 7, 10, 12, 15 mm
ACCESSORIES: Bar code scanner for next frame identification, support table, memory expansion and metal extension arms
WARRANTY: 2 yr mfr's / 1 yr wearables
Item #U500 VN4 Single-Channel Memory Program V-Nailer *call*
formerly **#VN4MP**

Item #U600 VN4 Multi-Channel Memory Program V-Nailer *call*
formerly **#VN4MC**

Item #F04032 Metal Extension Arms (old #291650010) *call*
Item #F04046 Table Support Brackets (set of 6) (old #A001) *call*
Item #F04076 Wood Support Table (old #A002) *call*
Item #04072 Bar Code Scanner *call*
Item #04073 USB Scanner Cable *call*

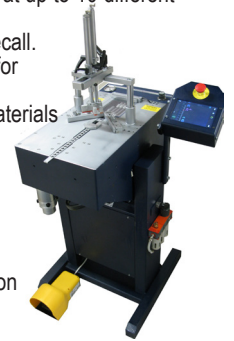

T400 PNEUMATIC DOUBLE MITRE SAWS

Built to last many years. Has a unique pneumatic control system which totally supports the weight of the cutting assembly. This allows for a very smooth downstroke, precise cuts and a quick return. Includes two 400mm-16" blades that are fixed at 45 degree angles and utilize Vertical Drop Technology, leaving a minimal amount of scrap. The vertical clamping system, equipped with 4 pneumatic hold downs, holds the moulding firmly to the work table to ensure a high quality cut every time. 2-handed push button operation. Adjustable blade descent for soft or hard woods. Adjustable cutting speed and adjustable blade height. Optional auto gage production feature. 32" W x 28" D x 62" H / Cut table height 37 1/2" / 126" W w/tables / Wt 920 lbs.

POWER SOURCE: 3 phase 230V, 100 psi feed, 4 cfm air consumption
MOULDING SPECS: Width: to 4"; Height to 3 1/2"

OUTFEED TABLE: 52" w/measurement gauges & 2 production stops
CUTS per HOUR: appx 800

SAFETY FEATURES: Lockout main power switch, Front cover safety switch, Dual actuator buttons lower blades, Emergency stop button, Lucite blade shield, Blades enclosure.

ACCESSORIES: Horizontal clamp kit, Measurement table extensions (add'l 48"), computerized optional automatic measuring gauge, saw blades

WARRANTY: 2 yr mfr's / 1 yr wearables
Item #T400 Pneumatic Double 16" Miter Saw *call*
Item #F04086 Auto Gauge for T400 *call*
Item #F05044 16" Wood Saw Blade (special order) *call*
Item #F04049 48" ext. arm Left (old #291650131) *call*
Item #F04033 48" ext. arm Right w/measure gauge (old #291650100) *call*
Item #HZS100 Horizontal clamp kit *call*

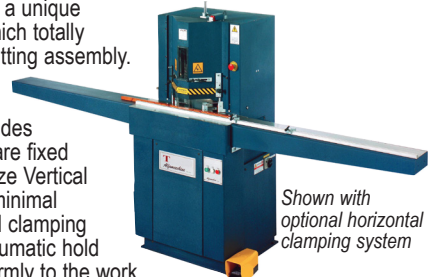

DISC SANDER

Accurately trues corners by rotating the 12" sanding disc against the mitre cut. This allows for perfect corners when joining and therefore a quality frame every time. Includes 45 degree template for accurate setting, allen wrenches, cleaning stick and 3 sanding disks. Wt 40 lbs.

WARRANTY: 2 yr mfr's / 1 yr wearables
Item #F04085 12" Disc Sander (old #MTS)
Item #F04035 Replacement Cleaning stick
Item #937 3M 12" Round Replacement 100 grit self-adhesive backed Sanding Discs



For all AMP V-Nailers: U200, U300, U400, U500 and U600
Item #F04025 AMP Yellow Rubber Pad for Medium Wood

Contact Decor for additional parts & accessories for all AMP machines.

DECOR SAW BLADES



Available in 10", 12" and 14" diameters with a standard 5/8" arbor. Specially designed to cut woods, metals or a combination of both and plastic. Unique tooth configuration as well as the finest carbide tips available will increase blade life and increase the time span between sharpening. Clearance ground and balanced for maximum performance. Professional sharpening service offered for all saw blades.

Item #	Diam.	Description	Cuts	# of Teeth	Price
10-CTW	10"	Special Carbide Tipped	Wood	80	
12-CTW	12"	Special Carbide Tipped	Wood	80	
14-CTW	14"	Special Carbide Tipped	Wood	100	
10-CTM	10"	Carbide Tipped "ULTRA" Metal		80	
12-CTM	12"	Carbide Tipped "ULTRA" Metal		80	
10-CBO	10"	Carbide Tipped Wood/Metal	Combination	80	
12-CBO	12"	Carbide Tipped Wood/Metal	Combination	80	
12-P	12"	Carbide Tipped for	Plastic	60	

DECOR PREMIUM BLADE RESHARPENING SERVICE

Item #	Description	Price
R80	10", 12" 14" Premium Carbide Blade Resharpener Service	

PISTORIUS ACCESSORIES



Fits Pistorius #MN-200 and #EMN-14 double miter saws.

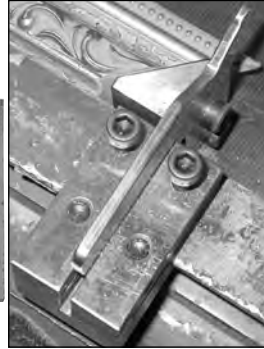

Item #	Description	Price
PCB-S	Phenolic Chip Breaker Support 2" round x 4" long	
PFI	Phenolic Fence Insert 1/2" x 2" x 2 1/4"	
289	Production Flip Stop for simultaneous multiple position stop gauging	

3M 12" ROUND SANDING DISC



- Designed specifically for 12" circular sanders.
- 100 grit aluminum oxide w/durable cloth backing resin bonded for heat resistance and long life.
- Self adhesive backing.

Item # 937

STEEL WIRE BRAD NAILS

The head and small diameter of these bright steel nails are for sinking beneath the wood surface. Use in any project where small nails are required. 1 lb. boxes.

Item #	Length	Gauge	Price
1517 <input checked="" type="checkbox"/>	3/4"	17	
1518 <input checked="" type="checkbox"/>	3/4"	18	
1519 <input checked="" type="checkbox"/>	3/4"	20	
1520 <input checked="" type="checkbox"/>	1"	16	
1521 <input checked="" type="checkbox"/>	1"	17	
1522 <input checked="" type="checkbox"/>	1"	18	
1523 <input checked="" type="checkbox"/>	1 1/4"	16	
1524 <input checked="" type="checkbox"/>	1 1/4"	17	
1525 <input checked="" type="checkbox"/>	1 1/4"	18	
1526 <input checked="" type="checkbox"/>	1 1/2"	16	
1527 <input checked="" type="checkbox"/>	1 1/2"	18	



FOOTCHOPPER BLADES and Resharpener Services



High quality blades made in Denmark using high speed tool steel available for your Pistorius, Morso, Hansen or Decor Choppers.

Item #	Description	Price
1300	Blades fit Pistorius, Morso, Hansen and Decor choppers. (10.5" x 3.0")	
1304	Premium Resharpener Service for these high quality razor sharp blades.	
1305	Premium Resharpener Service for all Reversible Blades.	

DECOR PREMIUM MITER VISES



- Tilts 90°
- Swivels 360°
- Holds any moulding up to 4" (#635)
- **Highest quality miter vise** in the industry with 50% thicker rabbet supports to hold moulding firmly
- Constructed of cast iron for years of service
- Jaws are offset to allow working space between the handles
- Glue shoot allows excess glue to drop out of the way
- Mounts to table securely.

Item #	Description	Price
635	4" capacity Miter Vise	

HOBBY KNIVES & BLADES

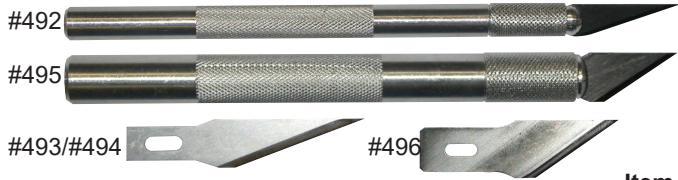

#	Description	Item Price Each
492 <input checked="" type="checkbox"/>	No. 1 Knife - 5" long, 5/16" diameter. Aluminum handle. For light to medium work. Comes w/#11 blade.	
495 <input checked="" type="checkbox"/>	No. 2 Knife - 5" long, 7/16" diameter. Aluminum handle. For medium to heavy work. Comes w/#24 blade.	
493 <input checked="" type="checkbox"/>	No. 11 Blades - For #492 (5 pack).	
494 <input checked="" type="checkbox"/>	No. 11 Blades - (100 pack)	
496 <input checked="" type="checkbox"/>	No. 24 Blades - Designed for close corner cutting	

REVERSIBLE TRIM KNIFE



"For left or right handers"

With its blade guard, it's easy to trim paper off the back of your picture frame. Guide runs along the side of the frame and blade cuts approximately 1/8" in from the side. Turn blade for right or left hand use (blade not included). Uses Decor #488 or #489 blades or Dexter blades #502 or #503.

SAVE 10%
 ITEM 1 for 4 @
 645

UTILITY KNIVES



Item #	Description	Price
498 <input checked="" type="checkbox"/>	Utility knife - Non slip grip, lightweight. Comfortable handle comes with 3 blades. Uses blades #486 & #487 (see above right).	
499 <input checked="" type="checkbox"/>	Retractable utility knife with 3 blades in handle. Uses blades #486 and #487 (see above right).	

HASSLE FREE TRIMMING KNIFE



Trims dust cover quickly and accurately. Pays for itself in time saved and by recycling your mat blades. For left and right hander. Comes with 1 blade. Uses Decor's #483 blades (pg 51).
Item #898

UTILITY KLEEN-CUT™ BLADES

For use with Decor #498, #499 and straight cuts on "Pre 1980" C & H Cutters

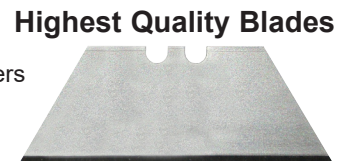

Item #	Description	List
486 <input checked="" type="checkbox"/>	2 pointed .017 razor type blades Same as Stanley #1991 blades (100 pack)	
487 <input checked="" type="checkbox"/>	Heavy Duty .025 thick blades (100 pack)	

RAZOR KLEEN-CUT™ BLADES



Premium Quality Blades



Item #	Description	1+	5+
480 <input checked="" type="checkbox"/>	#9 Single Edge Razor Blades - 100 pack/notched		
481 <input checked="" type="checkbox"/>	#12 Single Edge Razor Blades - 100 pack/notched		
482 <input checked="" type="checkbox"/>	#12 "Heavy Duty" Razor Blades - 100 pack/no notch		

#482 for bevel cuts on "Pre 1980" C & H Cutters

KLEEN-CUT™ REPLACEMENT BLADES



Can be used on Dexter, Logan, Alto and others

Item #	Description	Price Each
488 <input checked="" type="checkbox"/>	#3 Dexter Style (5 per pack)	
489 <input checked="" type="checkbox"/>	#3 Dexter Style (100 pack)	

DEXTER #3 REPLACEMENT BLADES



Original Dexter Brand

SAVE 10%

Item #	Description	Price/Pack	5+ Packs @
502 <input checked="" type="checkbox"/>	#3 Dexter (5 blades/pack)		
503 <input checked="" type="checkbox"/>	#3 Dexter (100 pack)		

PREMIUM RETRACTABLE BLADE / SCRAPER



Item # 497

This premium retractable scraper which uses single edge razor blades, retracts when not in use for easy pocket storage with one blade. Uses blades #480, #481 & #482 (see above).

FLETCHER 2200 Matboard / Foamboard Cutters

These manual Fletcher cutter systems create bevels and produced V-Grooves with ease in 4-ply matboards and cut straight lines up to 1/2".

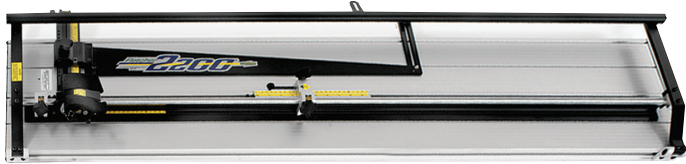

Includes:

- 1 2200 Mat Cutter
- 1 Sight Guide Gage
- 2 Squaring Blocks
- 10 Blades #F05012
- 10 Blades #F05004



Item #	Description	Price
F04681	F2200 48" Mat Cut System	
F04682	F2200 60" Mat Cut System	
F04622	F2200 Measuring Stops	
F04630	F2200 Right Squaring Extension	
F04631	F2200 Mat Clamp Lifters - set of 2	
F05004	Fletcher brand Utility/Rail Cutting Blades .017 100/box	
F05012	Fletcher brand Mat Blades .012 100/box	
F05015	Fletcher brand Mat Blades .015 100/box	
F05016	Fletcher brand Mat Blades Single Edge .015 100/box	
F12045	Fletcher F2200 Repair Kit: springs, bushings, bearings, strap	

F-60 Semi-Rigid / Flexible Cutter 60"

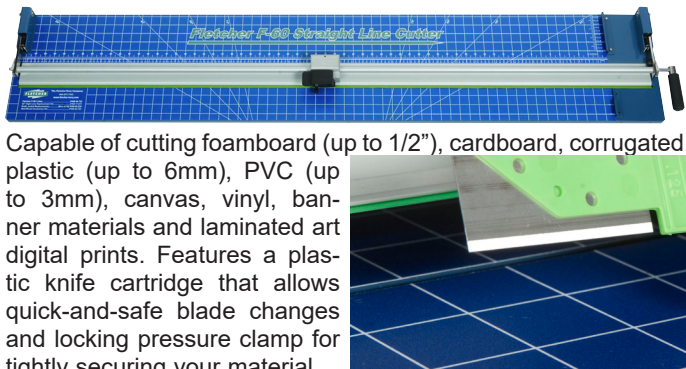

Capable of cutting foamboard (up to 1/2"), cardboard, corrugated plastic (up to 6mm), PVC (up to 3mm), canvas, vinyl, banner materials and laminated art digital prints. Features a plastic knife cartridge that allows quick-and-safe blade changes and locking pressure clamp for tightly securing your material.

#F05235

Item #	Description	Price
F04722	F-60 Substrate Cutter 60"	
F05235	F-60 Replacement Blades 10/box	

FLETCHER FSC Substrate Cutter



Substrate Cutting Capability

- Aluminum Sheets up to .063"
- Aluminum Composites up to 4mm
- Corrugated Plastics up to 1/2" (13mm)
- Glass/Mirrors up to 1/4" (6mm)
- PVC & Foamboard up to 1/2" (13mm)
- Acrylics/Plexiglass up to 1/4" (6mm)
- MDF up to 3/32" (2.4mm)

Includes:

- 1 FSC Unit (wall or free-standing)
- 1 1/2" Blade Holder
- 1 ACM Cutting Wheel Holder
- 1 Acrylic Blade Holder
- 1 Tube of 10 FSC Blades #F05222
- 1 Tube of 10 Acrylic Scoring Blades
- 1 Set of Aluminum Composite Wheels
- 1 Tool Caddy
- 2 Material Production Stops
- 1 Sight Laser Line
- 1 Manual

**Interchangeable
Cutting Head
Technology**

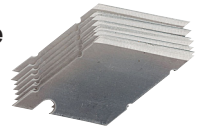

#F05222

Cuts clean, debris-free, no secondary processing. Can be placed in same room as printer, saving valuable shop floor space. Includes Laser Sight Line Cutting Guide that is adjustable for knife or wheel cutting operation and projects a cut line on the substrate, eliminating guess work and costly errors in a pre-print or post printing process. Mounts on wall or free-standing. Substantial cast aluminum cutting head, ergonomic "T" handle bar, power-lock rod and innovative glide bearing system. V-Groove Cutting. Fine adjustment increments for precise depth control. Has the ability of cutting aluminum sheets up to .063" in a single pass.

Item #	Description	NOW
F04720	FSC Multi-Material Cutter	
F02120	Steel Glass Wheel 120° 10/tube	
F05222	FSC Blades 10/tube	
F05712	Acrylic Scoring Blades 10/tube	

FLETCHER Fillet Chopper

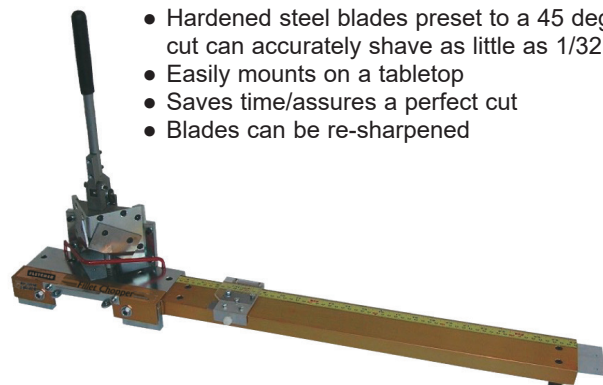

- Hardened steel blades preset to a 45 degree cut can accurately shave as little as 1/32 inch
- Easily mounts on a tabletop
- Saves time/assures a perfect cut
- Blades can be re-sharpened

Item #	Description	Price
F04900	Fillet Chopper	
F05700	Fillet Chopper-replacement blades: set of 2	

FLETCHER 3000 Multi-Material Cutters

The 3000 Wall Machine features a 3-position cutting turret that contains a glass cutting wheel unit, plastic scoring blade for acrylic materials, and mat/foam board cutting blade mounted in their respective positions on the turret for quick changeover from one material to another. A ramping feature allows the lifting of scoring wheel on top edge of glass resulting in a cleaner edge break when scoring glass. Handles material sheets up to 60" high (1.52m). Mounts on wall or freestanding installation.

Includes:

- 1 ea 3000 unit
(Main frame assembled, requires right support assembly by customer)
- 10 ea #F05001
Mat/Foamboard Blades
- 10 ea #F05712
Plastic Scoring Blades
- 10 ea #F02120
Glass Wheel Units

Substrate Cutting Capabilities

Glass & Mirror	Up to 1/4" (6mm)
Plastics & Acrylic	Up to 1/4" (6mm)
Cardboard	Up to 1/4"
Foamboard	Up to 1/4" (6mm)



Item #	Description	Price
F04711	F3000 48" Glass / Mat / Acrylic Cut System	
F04712	F3000 60" Glass / Mat / Acrylic Cut System	
F04101	F3000 / F3100 Mounting Stand	
F04112	F3000 Measuring Stop (recommended to buy w/unit)	
F05001	<input checked="" type="checkbox"/> M3000 Mat/Foamboard Blades 10 / tube	
F05003	<input checked="" type="checkbox"/> M3000 Mat/Foamboard Blades 100 / box	

FLETCHER Oval/Circle Glass Cutter

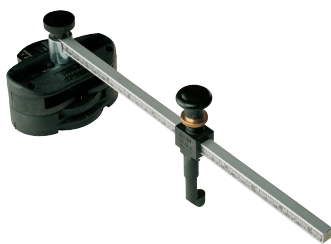

Suction cup keeps the cutter to the glass securely, allowing you to score oval and circles on flat and stained glass. A scale lets you set accurate measurements with a turn of a knob. Able to adjust offset setting for ovals from 4 1/2" - 24" and offset circles up to 21" in diameter. Uses a 134° tungsten carbide wheel.

Item #	Description	Price
F05221	Oval/Circle Glass Cutter	

FLETCHER 3100 Multi-Material Cutters

Versatile Wall Cutter designed with an interchangeable cutting head platform that uses multiple cutting blades, scoring tips and cutting wheel holders for cutting and scoring a large variety of materials. Handles material sheets up to 63" high (1.6m) and features an acrylic breakout function.

Mounts on wall or freestanding installation.

Includes:

- 1 ea 3100 unit
- 1 ea #F04114
Measuring Stop
- 4 Blade Holders
Mat/Foamboard, Acrylic/Plastic, Glass/Mirror, MDF
- 1 ea #F05715
MDF Cutting Wheel Set
- 10 ea #F05004
Mat/Foamboard Blades
- 10 ea #F05712
Plastic Scoring Blades
- 10 ea #F02120
Glass Wheel Units

Substrate Cutting Capabilities

Glass & Mirror	Up to 1/4" (6mm)
Plastics & Acrylic	Up to 1/4" (6mm)
Cardboard	Up to 1/4" (6mm)
Foamboard	Up to 1/4" (6mm)
Gator Board	up to 1/2" (13mm)
PVC	Up to 1/4" (6mm)
MDF	up to 3/32" (2.4mm)
Aluminum Sheets	up to .040



Interchangeable Cutting Head Technology
Cuts clean, debris-free, no secondary processing
Mounts on wall or free-standing
Cuts wide range of substrates

Item #	Description	Price
F04715	F3100 63" Glass / Mat / Acrylic Cut System	
F04101	F3000 / F3100 Mounting Stand	
F04114	F3100 Measuring Stop	
F05004	<input checked="" type="checkbox"/> Utility / Rail Cutting Blades 100 / box	
F05711	<input checked="" type="checkbox"/> M81 PVC Cutting Blades 10 / tube	
F12211	<input checked="" type="checkbox"/> Gatorboard Cutting Blade Holder	
F12213	<input checked="" type="checkbox"/> Acrylic/Plastic Cutting Blade Holder	
F12225	<input checked="" type="checkbox"/> PVC Double Blade Holder	

Accessories for Fletcher 3000 & 3100 Systems



#F02120
Steel Glass Wheel



#F05712
Acrylic Scoring Blade



#F03126
Carbide Glass Wheel

Item #	Description	Price
F02120	<input checked="" type="checkbox"/> Steel Glass 120° Cutting Wheel 10 / tube	
F03126	<input checked="" type="checkbox"/> Carbide Glass Cutting Wheel 1 / pkg	
F05712	<input checked="" type="checkbox"/> Acrylic Scoring Blades 10 / tube	

50 LOGAN FRAMER'S EDGE MAT CUTTERS

- 3 position straight blade holder
- Uses Decor #491 or Decor #479 Logan blades (pg 51).



Cost effective, versatile mat cutters which can handle projects from small to large.

- Easy-to-use production stops
- 9" (#670) & 27" squaring arm
- Pin-point accuracy on line-to-line cutting
- Aluminum channelled mat guide
- Ergonomic style cutting head
- Start and stop indicator
- Heavy duty construction
- 10 extra blades #479 (#670).

Item #	Description	Price Each
670	Logan 650-1 Framer's Edge Mat Cutter-40"	
982	Logan 655-1 Framer's Edge Mat Cutter-48"	
671	Logan 660 Professional Mat Cutter-60"	

LOGAN SIMPLEX PLUS MAT CUTTER



This machine includes a 27" squaring arm, nylon guided bevel cutting head, two guide rail stops, improved guide rail extrusion, durable gray laminated surface, and aluminum mat guide channels. Uses Decor #490 blades (see pg 51).

Item #	Description	Price Each
668	Logan 750 Simplex Plus Mat Cutter-40"	
669	Logan 760 Professional Mat Cutter-60"	

LOGAN COMPACT MAT CUTTER

"Trouble Free Mat Cutting at a Great Price"



Compact, dependable and versatile 32" mat cutting system with parallel mat guide and creative matting instruction. Includes bevel cutting heads and five extra blades. Uses Decor #490 blades (see pg 51).

Item #	Description	Price Each
660	Logan 301-1 Compact Mat Cutter	

LOGAN 2000 HAND MAT CUTTER



- 45° bevel push type cutter.
 - Retractable blade holder.
 - Can be used with rail kits and cutting boards.
- Uses Decor #490 blades (pg 51)

Item # 665

LOGAN 4000 HAND MAT CUTTER



- 45° bevel pull type cutter.
- Retractable blade holder and marking system.
- Can be used with rail kits and cutting boards
- Uses Decor #490 blades (pg 51)

Item # 666

LOGAN PLATINUM EDGE PROFESSIONAL #850, #855 & #860 MAT CUTTERS

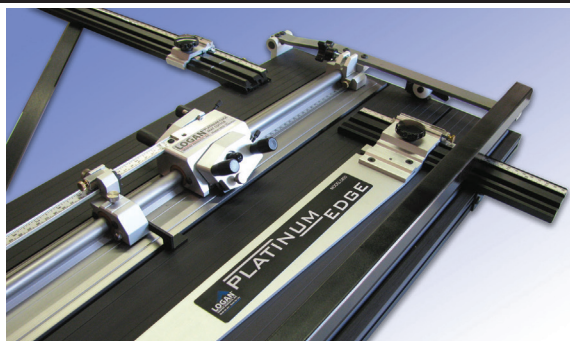

The NEW Logan Platinum Edge Models have it all! These cutters are solid from the ground floor. Featuring an aluminum base, super-smooth cutting head ball bearings, 4-ply and 8-ply cutting capability, quick-change magnetic blade cartridge, micro-adjustable magnetic moveable stop, 32" (81cm) removable scaled squaring arm and dual cutting head for both bevel and straight cuts. Uses Decor #483, #484 and #485 blades (pg 51).

Item #	Description	Price Each
938	Logan #850 Platinum Edge 40" Mat Cutter	
954	Logan #855 Platinum Edge 48" Mat Cutter	
981	Logan #860 Platinum Edge 60" Mat Cutter	

LOGAN 3 STEP OVAL and CIRCLE MAT CUTTER



An affordable mat cutter which accurately cuts a variety of sizes. It can cut beveled ovals from 3 1/4" x 4 1/2" to 20" x 23" and beveled circles from 4 1/2" to 20". Uses Decor #488 and #489 blades (see page 47). Logan #201

Item # 667

LOGAN F300-2 PRO JOINER

Drive one or two nails at a time into hard or soft woods and is ideal for production joining of duplicate frames using the same moulding size. Extremely precise and versatile, yet compact and economical, while producing professional results. Heavy duty professional style joiner for precise corner joints.

Includes:

- V-nail alignment pins
- sliding nail loading mechanism
- drives all nail sizes
- fully adjustable driving lever
- improved foot depth setting
- mouldings up to 2.5" wide
- drives 1 or 2 nails at a time
- quick-adjust corner clamp
- use on hard or soft woods
- can stack v-nails into the joint
- includes moulding support arms
- quick load V-nail holding system

Item #1546

DEXTER MAT CUTTER The Original Dexter Mat Cutter



Item #500

- Easily glides along a straight edge or template.
- Chrome plated for smooth movement on any board surface.
- Built-in alignment sighting.
- Cuts in either direction with either hand.
- Makes perfect straight & beveled cuts.
- Adjustable depth for cutting & scoring.
- Easy blade replacement.
- Comes complete with 5 No. 3 Dexter Blades. Uses Decor #488, #489, #502 or #503 blades (pg. 47)
- Comfortable to grip.

KLEEN-CUT™ LOGAN STYLE BLADES

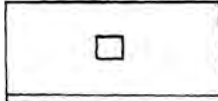

100 blades/box

Item #	Description	Fits Cutters #	Price
490 <input checked="" type="checkbox"/>	Logan Style 270 1 1/2" x .012	301, 301S, 401, 500, 700S, 700SGM, 701, 750, 760SGM, 1000, 2000, 3000, 4000	
491 <input checked="" type="checkbox"/>	Logan Style 269 1 1/2" x .015	350, 650, 660	

LOGAN BRAND #269 BLADES

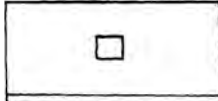

100 blades/box
1 1/2" x .015

Item #	Description	Fits Cutters #	Price
479 <input checked="" type="checkbox"/>	Logan Blade 269 compatible blade #491 above	Logan Cutter #650 (Decor #670) and Logan Cutter #660 (Decor #671)	

MAT CUTTER KLEEN-CUT™ BLADES



**Kleen-Cut™ blades for Fletcher,
C & H and Logan Mat Cutters
Highest Quality Blades**

FOR BEVEL CUTS

Item #	Description - 100 blades/pack	List	3+
483 <input checked="" type="checkbox"/>	#1200 - 0.012 Gauge - 1 3/4" for Regular Mat Board. Use 2 sides.		
484 <input checked="" type="checkbox"/>	#1500 - 0.015 Gauge - 1 3/4" Thicker blade for Rag Board, Double Thick and 8 ply Rag. Use 2 sides.		
485 <input checked="" type="checkbox"/>	#1500SE - 0.015 - 1 3/4" Chisel point edge, single bevel. Premium quality for thicker boards, straightest and cleanest cuts		

C + H™ Brand MAT CUTTER BLADES

For C + H Mat Cutters



#1327



#1330

Item #	Description - 100 blades/pack	Price
1327 <input checked="" type="checkbox"/>	#1200 - 0.012 Gauge For paper mats. Use 2 sides.	
1329 <input checked="" type="checkbox"/>	#1200SE - 0.012 Gauge Single bevel for straightest cut and cuts through thicker boards.	
1328 <input checked="" type="checkbox"/>	#1500 - 0.015 Gauge. More rigid than #1327. Use 2 sides. For denser boards, such as rag mats.	
1330 <input checked="" type="checkbox"/>	#1500SE - 0.015 Gauge Single bevel for straightest cut through thicker boards.	

VELCRO® BRAND PRODUCTS

Chevrons

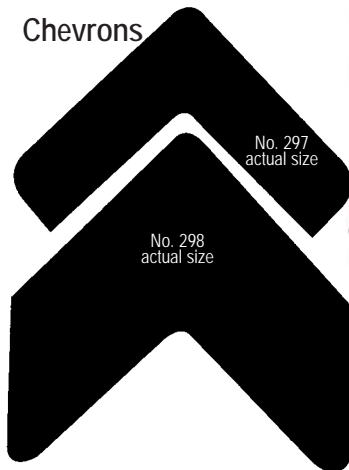

No. 297
actual size

No. 298
actual size

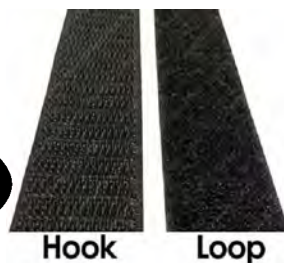

Hook

Loop

16-FOOT TAPE MEASURE



3/4" sturdy wide metal tape is housed in this heavy duty, rubber-protected measure. Three convenient separate locking mechanisms (front, side and bottom) hold the metal securely in place while you measure. Includes belt clip and hand strap. 16 feet (490 cm).

SAVE 20%

Item 1 for 3 @

#768

STRAIGHT EDGED RULERS



	Item #	Length	Cost/Each
Durable, lightweight aluminum with easy to read thermobonded numbers - non rusting.	512 <input checked="" type="checkbox"/>	36"	
	513	48"	
	514	60"	
	515	96"	

CENTER FINDING RULER



These aluminum center finding rules are calibrated in 16th's and centimeters (cm's) allowing you to quickly find the center of any 2 or 3 dimensional object. Simply place the center finding rule on the "object" so that the same measurement appears to the left of the "0" mark as appears to the right of the "0" mark. The "0" mark will then indicate the exact center.

Item #	Length	Price
543 <input checked="" type="checkbox"/>	24"	
544 <input checked="" type="checkbox"/>	36"	

SAFETY GOGGLES



Frame molded for extra firmness and greater impact resistance to protect your eyes.

Item # 654 \$8.99 each

Black pressure sensitive chevron fasteners for corner samples. 25 Yard Roll.

Item #	Description	Qty/Roll	Price/Roll
297	Small Chevrons	1500	
298	Medium Chevrons	900	

Pressure sensitive hook & loop fastening tape. 25 Yard Roll

Item #	Desc.	Color	Price/rl
300	5/8" Hook	Black	
1415	5/8" Hook	White	
301	5/8" Loop	Black	
1416	5/8" Loop	White	
302	1" Hook	Black	
1417	1" Hook	White	
303	1" Loop	Black	
1418	1" Loop	White	

Item #	Description	Price/pack
304	1/2" Hook - 100/pack	
305	1/2" Loop - 100/pack	

Foam backed loop fabric (for use with Velcro hook). Sold per yard

Item #	Description	Price/yd	11+ yds	26+ yds	50+ yds
308	Black-60" wide		Save 5%	Save 10%	Save 15%

PROFESSIONAL Canvas Stretching Pliers



Item # 934

- Heavy duty pliers for all types of canvas for professionals who demand the best.
- 8" long with 3" non-slip jaw fits comfortably in your hand for easy use.

CHROME CANVAS STRETCHING PLIERS



Item # 935

- Heavy duty chrome plate steel.
- Spring return handle.
- 8" long with 2 1/4" serrated jaws provide perfect non-slip canvas grip.



EXPRESSION TACKING IRON



Mfr #2280

Designed to tack materials into position on a substrate using the base of the shoe to melt heat-activated adhesives. Prevents the material from shifting before processing in the dry mounting press. Non-stick surface on the shoe. Built with a preset, self-regulating control for safe operation and long life.

Item #1396



HOT/COLD GLASS TOP VACUUM PRESSES



- Innovative glass heating system
- Sturdy construction
- Auto cycle cut-off
- Manual override for maximum flexibility
- Hot or cold usage
- Pressure control valve
- Digitally controlled heat and time settings.

Suitable for all mounting, heatsealing and canvas bonding processes. This range of glass top vacuum presses has been designed with standard display formats in mind. Each model is capable of handling the widest variety of materials from foam board and wood to photos, art prints and delicate fabrics. Incorporating the highly effective glass heating system, these presses produce a very even spread of heat across the work surface, leading to a superior quality of surface finish. All models include a built-in, digitally controlled timer. This timer can be set for any chosen period and will cut off the pressure at the end of the programmed cycle. A manual override switch allows the program to be interrupted at any time. This gives the operator maximum flexibility, ease of use and optimum quality results. The degree of pressure applied can also be controlled to assist when processing foam centered board or delicate subjects such as fabrics.

Item No.	Overall Size	Diaphragm Area
VACUUM PRESSES		
HGP260	39" x 51"	36" x 48"
HGP360	47" x 71"	44" x 68"

HOT/COLD COMBO VACUUM PRESSES



Touch-pad controls assure consistency and are user-friendly with easy-to-read digital displays. Programmable systems controller allows you to select from 6 factory-installed programs for temperature and dwell time, or easily pre-set you own combinations. Includes end of cycle signal. Supplied with a maintenance-free vacuum

pump and twistlock plug. CUL listed. 230 VAC, single phase

Item No.	Expression #	Overall Size	Diaphragm Area
VACUUM PRESSES:			
976	4468H	72" x 57"	44" x 68"
977 *	5298H	107" x 65"	48" x 96"

* Stand included
FLOOR STANDS: Stands for our vacuum presses above. *Call for pricing*
 976F for model 976

MECHANICAL DRY MOUNT PRESS

Table-top, heat-activated dry mounting systems built to stand up to heavy use for years. They utilize uniform heat and pressure to mount, laminate, and texturize prints on substrates up to 1" thick (model #979). Features electronic temperature control (100°-300°) with easy-to-read digital display and touch pad controls. Capable of finishing pieces even larger than the press itself. Six pre-set programs. UL listed. 120V, 12 amp.

Item No.	Expression #	Size	Heating Area	Price
978	250	27" x 23"	18.5" x 23"	Call
979	550	39" x 37"	26" x 34"	Call

See back cover for details

Eff. 6/03/22

32"x40" & 40"x60" Matboards on this page combine with Bainbridge and Crescent for Quantity discounts!



- 100% Cotton Rag
- Highest Archival Quality
- Neutral pH / Acid-Free
- Fade, Scuff & Bleed Resistant
- Buffered with Calcium Carbonate

Decor is proud to introduce the Essence™ Museum Board collection. The collection meets all industry standards for consistency, preservation and quality. We selected the most popular colors making the Essence™ Museum Board the perfect archival choice for conservators, museums, libraries and framers worldwide.

Only the finest color pigments are used to create our museum board colors. The colors are solid throughout and are fade, scuff and bleed resistant. This ensures cleanliness and excellent cutting characteristics.

Made from pure 100% cotton throughout and earning the Seal of Cotton trademark, the Essence™ collection is naturally free of acid, lignin and other non-cellulose containments. Buffered with calcium carbonate, the pure cotton composition creates a strong, rigid matboard that is pH neutral.

The Essence™ Museum Board collection passed the Image Permanence Institute, Photographic Activity Test (P.A.T.) and exceeds the Library of Congress Standards for image permanence. Standing the test of time, the cotton Essence™ Museum Board collection is ideal for: matting, mounting and preservation of fine prints, precious documents, and traditional and digital photographs.

Category	Size	17% 50+ Shts	7% 25-49 Shts	List 1-24 Shts
<u>2-ply MUSEUM BOARD</u>				
E1322 White, E2322 Warm White, E3322 Antique	32x40			
E1402 White	40x60			
<u>4-ply MUSEUM BOARD</u>				
E1324 White, E2324 Warm White, E3324 Antique	32x40			
E4324 Black	32x40			
E1404 White, E2404 Warm White, E3404 Antique	40x60			
E4404 Black	40x60			
<u>8-ply MUSEUM BOARD</u>				
E1328 White, E2328 Warm White, E3328 Antique	32x40			
E1408 White, E2408 Warm White	40x60			

Order CS-ES Essence™ Corners / Made in the U.S.A.



Known by museum curators and other art experts for more than 50 years, Rising Museum & Conservation Boards are a range of Rag Mat Museum Mats and conservation mat boards made to meet the strict Library of Congress standards.

Rising Museum Board

Rising 100% Cotton Museum Boards are the first choice of framers and museums for preservation matting and mounting of fine prints and precious documents. Boards are acid-free, neutral pH and buffered with calcium carbonate. Many artists use Rising Museum Mounting Board for various fine

art techniques such as drawing, charcoal, pastel, air brush, acrylic & silkscreen.

Rising Museum Barrier Paper

Museum Barrier Papers are 100% cotton, neutral pH, chlorine-free, buffered with calcium carbonate. It can be used as backing for fine art, interleaving paper or print folder to protect high quality artwork. One can also use this as a drawing paper, as well as for offset lithography and silkscreen.

Category	Size	Qty per Pack	17% 50+ Shts	7% 25-49 Shts	List 1-24 Shts
<u>1-Ply RAG MAT MUSEUM BOARD</u>					
R401144 White Barrier Paper	32 x 40	200			
<u>2-Ply RAG MAT MUSEUM BOARD</u>					
R401952 White,	32 x 40	100			
R403198 Warm White, R405601 Antique					
R401755 White	40 x 60	50			
<u>4-Ply RAG MAT MUSEUM BOARD</u>					
R400906 Cream, R401956 Natural,	32 x 40	50			
R402447 Warm White, R402872 White, R405602 Antique, R405902 Polar White					
R400975 Zinc	32 x 40	50			
R405820 Black	32 x 40	50			
R402490 White,	40 x 60	25			
R403196 Warm White, R405603 Antique					
R405821 Black	40 x 60	25			

Category	Size	Qty per Pack	17% 50+ Shts	7% 25-49 Shts	List 1-24 Shts
<u>8-Ply RAG MAT MUSEUM BOARD</u>					
R401700 White, R401710 Warm White,	32 x 40	20			
R401720 Antique, R401730 Natural, R405904 Polar White					
R401701 White, R401711 Warm White,	40 x 60	10			
R405905 Polar White					
			SAVE 25%		
	Size	Qty per Pack	Full Box Price	List 1 Sheet	
<u>4-Ply RAG MAT MUSEUM BOARD</u>					
R401820 Warm White	48 x 72	20			
[Single sheet price includes one sheet #204 48"x96" foamboard]					
R401805 Warm White	48 x 96	10			
[Single sheet price includes one sheet #204 48"x96" foamboard]					
R402873 White, R60104 Warm White	60 x 104	10			
[Single sheet price includes one sheet #208 60"x120" foamboard]					

*Full Box Price DOES NOT include foamboard.

DECOR PREMIUM QUALITY VALUE LINE MATBOARDS

"White Core" Mats - 32" x 40"

- 14 "white cores" in must have colors to meet all your design needs.
- 4-ply thickness for crisp uniform bevels.
- Recommended for decorative framing.

SAVE 25%

SAVE 25%

Item #	Color	25 shts/item	1 for
BC048	Maroon		
BC061	Super White		
BC065	Fabric White		
BC088	TV Grey		
BC203	Cream		
BC346	Brazilian White		
BC377	Firecracker		

Item #	Color	25 shts/item	1 for
BC709	Extreme White		
BC711	Black		
BC770	Soapstone		
BC868	Forest Green		
BC885	Delft Blue		

DECOR PREMIUM QUALITY VALUE LINE MATBOARDS

- The Most Popular Colors
- Full 4-ply thickness for crisp uniform bevels without the wavy edge experienced with low quality OEM boards.
- Clean, clear and smooth paper pulp core for fast, sharp volume cuts.
- Full weight surface paper with no core show through.

32" x 40"

SAVE 25%

SAVE 25%

SAVE 25%

Item #	Description/Color	25 shts/item	1 for	Item #	Description/Color	25 shts/item	1 for	Item #	Description/Color	25 shts/item	1 for
VB038	Maroon			VB519	Soft Yellow			VBW334	Bottle Blue White Core		
VB079	Yorktown Blue			VB520	Golden			VBW402	White-White Core		
VB097	Polar White			VB522	Palm			VBW452	Umber White Core		
VB102	Hollyhock			VB524	Hunter Green			VBW459	Deep Red-Wht Core		
VB106	Weatherwood			VB527	Bright Green			VBW472	Silver		
VB110	Buttercup			VB531	Aqua Marine			VBW516	Heritage Gray-Wht Core		
VB115	Hazelnut			VB532	Reef			VBW2102	Golf Ball		
VB120	Purple Iris			VB534	Fountain Blue			VBX501	Papyrus		
VB125	Spruce			VB535	Gray						
VB126	French Vanilla			VB537	Bluestone						
VB127	Forest Shadow			VB538	Brittany Blue						
VB130	Silver Mist			VB541	Steel Blue						
VB131	Midnight Blue			VB542	Blue						
VB132	Mojave			VB548	Pansy						
VB143	Bay Blue			VB549	Lavender						
VB146	Seafoam			VB550	Cardinal						
VB151	Soft Pink			VB556	Terra-Cotta						
VB152	Tangerine			VB557	Autumn						
VB153	Brick			VB565	Terrazzo						
VB155	Pumice			VB571	Pitch						
VB161	Granite			VB572	Black Pebble						
VB163	Oyster Shell			VB574	Silver Foil						
VB165	Raspberry			VB577	Classic Gold						
VB169	Bamboo			VB697	Polar White-Blk Core						
VB221	Black			VB700	Carmelian Orange						
VB222	Smooth White			VB703	Marzipan						
VB235	Chamois			VB706	Loam						
VB239	Toasted Almond			VB710	Aged Oak						
VB251	Antique White			VB718	Valley Green						
VB252	Cappuccino			VB771	Pure Gray						
VB253	Pale Laurel			VB772	Dover White						
VB334	Bottle Blue			VB797	Beach						
VB357	Rattan			VB802	Mid-Gray						
VB358	Dill			VB1101	Yankee Blue Pinstripe (40" vert'l stripes)						
VB361	Pistachio			VB5074	Frosted Silver						
VB402	White			VB5075	Frosted Gold						
VB403	Pure White			VB5570	Gold						
VB404	Textured Black			VB6277	Smooth Blk-Blk Core						
VB407	Cream Linen			VB7245	Belgique-Bruxelles						
VB450	Spice			VB7246	Belgique-Antwerpen						
VB452	Umber			VB62100	Basketball-Blk Core						
VB455	Aqua Blue			VB62101	Football-Blk Core						
VB459	Deep Red			VB90C	Cream Dbl Thick						
VB461	Crisp			VBSRM90	White Dbl Thick						
VB464	Splash			VBW038	Maroon-Wht Core						
VB472	Silver			VBW97	Polar White-Wht Core						
VB473	Topaz			VBW127	Forest Shadow-Wht Core						
VB500	Canvas			VBW131	Midnight Blue-Wht Core						
VB502	Cloud			VBW221	Smooth Blk-Wht Core						
VB508	Ecru			VBW222	Smooth Wht-Wht Core						
VB511	Beige			VBW251	Antique White-Wht Core						
VB514	Seaside			VBW252	Cappuccino-Wht Core						
VB518	Pear	\$3.81	\$5.08								

40" x 60"

SAVE 25%

Item	Desc./Color	25 shts/item	1 for
VB897	Polar White		
VB8163	Oyster Shell		
VB8221	Black		
VB8222	Smooth White		
VB8334	Bottle Blue		
VB8402	White		
VB8403	Pure White		
VB8450	Spice		
VB8459	Deep Red		
VB8461	Crisp		
VB86277	Smooth Black-Black Core		
VBW897	Polar White-White Core		
VBW8221	Smooth Black-White Core		
VBW8222	Smooth White-White Core		

SUEDE 32" x 40"

SAVE 25%

Item	Desc./Color	25 shts/item	1 for
VB9125	Winter Suede		
VB9128	Grove Suede		
VB9129	Treeline Suede		
VB9132	Brook Suede		
VB9133	Torrent Suede		
VB9134	Berry Suede		
VB9135	Blaze Suede		
VB9137	Thicket Suede		
VB9138	Prairie Suede		
VB9140	Smoke Suede Suede		
VB9141	Ash Suede		
VB9142	Night Sky Suede		
VB9146	Red Sky Suede		

DECOR PREMIUM QUALITY MATBOARD "SECONDS"

SAVE 10%

All 4-ply assorted colors.

Item	Size	25 sheets/item	Min. 1 sheet
MS	32"x40"		
MS46	40"x60"		



Crescent Select for Conservation Framing

The fastest growing conservation quality 100% alpha-cellulose line in the industry. Completely safe for your customers' art. All Crescent Select products are acid-free, lignin-free and meet

all requirements for conservation matting. Conservation quality surface papers offer optimum fade and bleed resistance. Produced using only 100% virgin alpha-cellulose fibers for lasting quality. Acid-free and lignin-free for maximum artwork protection.

Crescent Select 32" x 40" 4-ply 25/pack						
20% Full Pack		17% 50+ sheets		7% 25-49 sheets		List 1-24 sheets

Item #	Color	Item #	Color	Item #	Color	Item #	Color	Item #	Color	Item #	Color	Item #	Color
C5647	Carnation	C9527	Wise Green	C9567	Colton Candy	C9610	Code Red	C9811	Putty	C9879	Purple Iris		
C5648	Peony	C9530	Hedgehog	C9570	Sushi	C9611	Peat Moss	C9812	Old Ivory	C9880	Royal Blue		
C5651	Bluebird	C9531	Spinach	C9574	Marooned	C9612	Fuzz	C9813	Sandstone	C9881	Real Teal		
C9500	White Glove	C9533	Bonsai	C9576	Valentine	C9613	Super White	C9814	Autumn Gold	C9882	Cornflower		
C9501	White Collar	C9535	Turf	C9579	Mudslide	C9614	Glow	C9820	Forest Green	C9884	Napa Valley Red		
C9502	White Sale	C9536	Fronde	C9581	Hot Sauce	C9615	Cream Puff	C9822	Sierra Olive	C9885	Jeans		
C9503	White Hot	C9537	Envy	C9584	Catcher's Mitt	C9616	Honey Wheat	C9826	Mocha Green	C9886	Dark Purple		
C9504	White Lie	C9538	Deep Woods	C9585	Root Beer	C9618	Tater	C9827	Flag Blue	C9887	Black-n-Blue		
C9505	White Wash	C9539	Riptide	C9586	Brown Sugar	C9621	Bud	C9830	Blue Night	C9888	Electric Blue		
C9506	Egg White	C9542	Blue Monday	C9587	Milk Chocolate	C9624	Scrubs	C9831	Blue Iris	C9889	Deep Blue		
C9507	White Elephant	C9544	Chicago Blues	C9590	Fresh Brew	C9625	Blue Moon	C9832	Stormy Blue	C9892	Deep Orange		
C9508	White Sands	C9545	Glacier	C9591	Top Soil	C9627	Ink Spot	C9833	Orange Ade	C9893	Blaze Orange		
C9509	Half & Half	C9546	Blue Satin	C9592	Blizzard	C9629	Rhino	C9834	Russet	C9894	Golden		
C9510	Froth	C9547	In A Fog	C9593	Gravel Road	C9630	Meteorite	C9837	All American Red	C9895	Pewter		
C9511	Fossil	C9548	Blue Lilac	C9594	Concrete	C9631	Coal Mine	C9838	Brick	C9896	Lawn		
C9512	Mummy	C9549	Inlet	C9595	Urban	C9632	Black Belt	C9839	Cabernet	C9898	Burnt Orange		
C9513	Sandtrap	C9550	Cabana	C9596	Cubicle	C9633	Morning	C9840	Plum	C9899	Red Hot		
C9514	Toasty	C9551	Blue Wave	C9597	Field Mouse	C9634	Cloudburst	C9846	Dark Shale				
C9515	Wet Sand	C9552	NYPD	C9598	Before Dark	C9635	Nightfall	C9848	Jet Black				
C9516	Tusk	C9553	Moody Blue	C9599	After Dark	C9800	Baker's White	C9861	York				
C9518	Summer	C9554	Pharaoh	C9600	Batter	C9801	Chalk	C9865	Kensington				
C9519	Curry	C9555	Steel Drum	C9601	Sandpaper	C9802	White Art	C9866	Plymouth				
C9520	Haystack	C9556	Tempest	C9602	Guacamole	C9804	Pure White	C9872	Irish Green				
C9521	Gold Rush	C9557	Pigeon	C9603	Underbrush	C9805	Coconut Milk	C9874	Red Line				
C9522	Oleo	C9558	Geode	C9604	Blarney	C9806	Dove	C9875	Saffron				
C9523	Omelet	C9560	Easter Egg	C9605	Tealy Dan	C9807	Off White	C9876	Mandarin				
C9524	In The Buff	C9562	Grape Jelly	C9606	Jaws	C9808	Ivory Art		Orange				
C9525	Sage Advice	C9564	Purple Mountain	C9607	Blue Chip	C9809	Twilight	C9877	Midnight Green				
C9526	Pickle	C9565	Quarry	C9608	Sweet Tart	C9810	Tawny	C9878	Aqua Green				

Crescent Select 32" x 40" 4-ply				
17% 50+ sheets		7% 25-49 sheets		List 1-24 sheets

Item #	Color	Item #	Color	Item #	Color
C5598	Etched Black	C9850	Silver	C9854	Rose
C9749	Rose Platinum	C9851	Gold Nugget	C9855	Spanish Gold
C9849	Antwerpen	C9852	Gold	C9856	Sun
		C9853	Bruxelles	C9870	Silver Star

Crescent Select Etched Metals 32" x 40" 4-ply				
17% 50+ sheets		7% 25-49 sheets		List 1-24 sheets

Item #	Color	Item #	Color	Item #	Color
C5400	Brushed Brass	C5402	Gunmetal	C5403	Oil-Rubbed Bronze

Crescent Select Accents 32" x 40" 4-ply				
17% 50+ sheets		7% 25-49 sheets		List 1-24 sheets

Item #	Color	Item #	Color
C9735	Earthen - Denali	C9737	Earthen - Gobi
C9736	Earthen - Sand Dune	C9739	Earthen - Mesa

Crescent Select Golf Ball 32" x 40" 4-ply				
17% 50+ sheets		7% 25-49 sheets		List 1-24 sheets

Item #	Color
C9744	Golf Ball

Crescent Select Pebble Beach 32" x 40" 4-ply				
17% 50+ sheets		7% 25-49 sheets		List 1-24 sheets

Item #	Color	Item #	Color
C5657	Moonlit Sand	C5698	Silver Sand
C5658	Bronzed Sand	C5699	Graphite Sand

Crescent Select 32" x 40" 6-ply				
17% 50+ sheets		7% 25-49 sheets		List 1-24 sheets

Item #	Color	Item #	Color	Item #	Color
C29500	White Glove	C29505	White Wash	C29599	After Dark
C29502	White Sale	C29507	White Elephant		

Crescent Select 32" x 40" 8-ply				
17% 50+ sheets		7% 25-49 sheets		List 1-24 sheets

Item #	Color	Item #	Color	Item #	Color
C229502	White Sale	C229598	Before Dark	C229848	Jet Black
C229508	White Sands	C229613	Super White		



Crescent Select 40" x 60" 4-ply
 17% 7% List
 50+ sheets 25-49 sheets 1-24 sheets

Item #	Color	Item #	Color	Item #	Color
C89500	White Glove	C89613	Super White	C89834	Russet
C89501	White Collar	C89614	Glow	C89835	Harvest Brown
C89502	White Sale	C89618	Tater	C89837	All American Red
C89505	White Wash	C89632	Black Belt	C89838	Brick
C89506	Egg White	C89633	Morning	C89839	Cabernet
C89507	White Elephant	C89634	Cloudburst	C89840	Plum
C89508	White Sands	C89635	Nightfall	C89848	Jet Black
C89511	Fossil	C89800	Baker's White	C89861	York
C89514	Toasty	C89801	Chalk	C89865	Kensington
C89516	Tusk	C89804	Pure White	C89874	Red Line
C89518	Summer	C89806	Dove	C89876	Mandarin Orange
C89520	Haystack	C89807	Off White	C89877	Midnight Green
C89527	Wise Green	C89808	Ivory Art	C89881	Real Teal
C89533	Bonsai	C89809	Twilight	C89882	Cornflower
C89542	Blue Monday	C89813	Sandstone	C89886	Dark Purple
C89552	NYPD	C89814	Autumn Gold	C89889	Deep Blue
C89553	Moody Blue	C89815	Fawn	C89892	Deep Orange
C89554	Pharoah	C89820	Forest Green	C89894	Golden
C89574	Marooned	C89822	Sierra Olive	C89899	Red Hot
C89591	Top Soil	C89826	Mocha Green		
C89592	Blizzard	C89827	Flag Blue		
C89598	Before Dark	C89830	Blue Night		
C89599	After Dark	C89832	Stormy Blue		
C89601	Sandpaper	C89833	Orange Ade		
C89610	Code Red				

Brite Cores 32" x 40" 8-ply
 17% 7% List
 50+ sheets 25-49 sheets 1-24 sheets

Item #	Color	Item #	Color
CBR214921	Black on Blue	CBR234921	Black on Red
CBR214987	White on Blue	CBR234987	White on Red
CBR224921	Black on Green	CBR244921	Black on Yellow
CBR224987	White on Green	CBR244987	White on Yellow

Select Conservation Solids
 Conservation grade surface papers for optimum bleed and fade resistance. 100% virgin alpha cellulose core and backing papers.

Select Conservation Solids 32" x 40" 4-ply
 17% 7% List
 50+ sheets 25-49 sheets 1-24 sheets

Item #	Color	Item #	Color	Item #	Color
C5700	Vivid White	C5704	Cream	C5712	Cloud Gray
C5701	Arctic White	C5705	Buff	C5713	Neutral Gray
C5702	White	C5706	Tan		
C5703	Antique White				

Select Conservation Solids 32" x 40" 4-ply
 17% 7% List
 50+ sheets 25-49 sheets 1-24 sheets

Item #	Color	Item #	Color	Item #	Color
C5708	Dark Brown	C5710	Dark Gray	C5714	Classic Gray
C5709	Gray	C5711	Deep Black		

Select Conservation Solids 32" x 40" 8-ply
 17% 7% List
 50+ sheets 25-49 sheets 1-24 sheets

Item #	Color	Item #	Color	Item #	Color
C25700	Vivid White	C25703	Antique White	C25706	Tan
C25702	White	C25704	Cream	C25712	Cloud Gray

Select Conservation Solids 32" x 40" 8-ply
 17% 7% List
 50+ sheets 25-49 sheets 1-24 sheets

Item #	Color
C25711	Deep Black

Select Conservation Solids 40" x 60" 4-ply
 17% 7% List
 50+ sheets 25-49 sheets 1-24 sheets

Item #	Color	Item #	Color	Item #	Color
C85700	Vivid White	C85704	Cream	C85713	Neutral Gray
C85702	White	C85706	Tan		
C85703	Antique White	C85712	Cloud Gray		

Select Conservation Solids 40" x 60" 4-ply
 17% 7% List
 50+ sheets 25-49 sheets 1-24 sheets

Item #	Color	Item #	Color
C85711	Deep Black	C85714	Classic Gray

Select Conservation Solids 40" x 60" 8-ply
 17% 7% List
 50+ sheets 25-49 sheets 1-24 sheets

Item #	Color	Item #	Color	Item #	Color
C825700	Vivid White	C825703	Antique White	C825706	Tan
C825702	White			C825712	Cloud Gray

Crescent Select 40" x 60" 4-ply
 17% 7% List
 50+ sheets 25-49 sheets 1-24 sheets

Item #	Color	Item #	Color	Item #	Color
C85598	Etched Black	C89850	Silver	C89854	Rose
C89521	Gold Rush	C89851	Gold Nugget	C89855	Spanish Gold
C89849	Antwerpen	C89853	Bruxelles	C89870	Silver Star

Crescent Select 40" x 60" 8-ply
 17% 7% List
 50+ sheets 25-49 sheets 1-24 sheets

Item #	Color	Item #	Color	Item #	Color
C8229502	White Sale	C8229598	Before Dark	C8229848	Jet Black
C8229508	White Sands	C8229613	Super White		

BriteCores

Acid-free and lignin-free surfaces and core. They meet the industry's highest standards for conservation matting. One board, two usable surfaces, acid-free and lignin-free.

Brite Cores 32" x 40" 4-ply
 17% 7% List
 50+ sheets 25-49 sheets 1-24 sheets

Item #	Color	Item #	Color	Item #	Color
CBR14921	Black on Blue	CBR44921	Blk on Yellow	CBR74921	Black on Pink
CBR14987	White on Blue	CBR44987	Wht on Yellow	CBR74987	White on Pink
CBR24921	Black on Green	CBR54921	Blk on Orange	CBR84921	Black on Aqua
CBR24987	White on Green	CBR54987	Wht on Orange	CBR84987	White on Aqua
CBR34921	Black on Red	CBR64921	Blk on Purple		
CBR34987	White on Red	CBR64987	Wht on Purple		

Brite Cores 40" x 60" 4-ply
 17% 7% List
 50+ sheets 25-49 sheets 1-24 sheets

Item #	Color	Item #	Color
CBR814987	White on Blue	CBR834921	Black on Red
CBR824921	Black on Green	CBR834987	White on Red
CBR824987	White on Green	CBR844921	Black on Yellow
		CBR844987	White on Yellow



Select Conservation Solids 40" x 60" 8-ply
 17% 7% List
 50+ sheets 25-49 sheets 1-24 sheets

Item #	Color
C825711	Deep Black

Linen Select Fabrics

Acid-free and lignin-free. Alpha-cellulose based matboards are suitable for conservation framing and as an alternative to non-conservation matting. Meets conservation standards. Surface papers are pigmented for fade and bleed resistance. Intended for: Fine art prints, Limited edition, Valuable documents and Photography.

Classic Linen Select Fabrics 32" x 40" 4-ply
 17% 7% List
 50+ sheets 25-49 sheets 1-24 sheets

Item #	Color	Item #	Color
C5520	Classic Beige	C5527	Deep Red
C5521	Noir	C5533	Vintage White
C5526	English Taupe		

Classic Linen Select Fabrics 40" x 60" 4-ply
 17% 7% List
 50+ sheets 25-49 sheets 1-24 sheets

Item #	Color	Item #	Color	Item #	Color
C85520	Classic Beige	C85521	Noir	C85533	Vintage White

Jute Select Fabrics

Rustic texture surfaces with bright white acid-free and lignin-free core and backing.

Jute 32" x 40" 4-ply
 17% 7% List
 50+ sheets 25-49 sheets 1-24 sheets

Item #	Color	Item #	Color	Item #	Color
C5539	Cream	C5542	Black	C5543	Barn Red
C5540	Barnwood			C5654	Natural

Jute 40" x 60" 4-ply
 17% 7% List
 50+ sheets 25-49 sheets 1-24 sheets

Item #	Color	Item #	Color	Item #	Color
C85539	Cream	C85542	Black	C85654	Natural
C85540	Barnwood				

Shimmer Linens Select Fabrics

Luxurious Fabric surfaces with bright white acid-free and lignin-free core and backing.

Shimmer Linens 32" x 40" 4-ply
 17% 7% List
 50+ sheets 25-49 sheets 1-24 sheets

Item #	Color	Item #	Color
C5660	White Shimmer	C5852	Silver Shimmer
C5661	Ivory Shimmer	C5853	Ebony Shimmer
C5851	Golden Shimmer		

Shimmer Linens 40" x 60" 4-ply
 17% 7% List
 50+ sheets 25-49 sheets 1-24 sheets

Item #	Color	Item #	Color	Item #	Color
C85660	White Shimmer	C85661	Ivory Shimmer	C85853	Ebony Shimmer

Suede Select Fabrics

Luxurious Fabric surfaces with bright white acid-free and lignin-free core and backing

Suede Select 32" x 40" 4-ply
 17% 7% List
 50+ sheets 25-49 sheets 1-24 sheets

Item #	Color	Item #	Color	Item #	Color
C5500	Treeline	C5507	Graphite	C5515	Thicket
C5501	Brook	C5508	Cocoa	C5633	White
C5502	Torrent	C5509	Sunrise	C5636	Purple Torch
C5503	Berry	C5510	Red Sky	C5637	Leaf
C5505	Firelight	C5511	Light Grey	C5638	Tile Blue
C5506	Night Sky	C5512	Clementine	C5639	Twig

Suede Select 40" x 60" 4-ply
 17% 7% List
 50+ sheets 25-49 sheets 1-24 sheets

Item #	Color	Item #	Color
C85500	Treeline	C85508	Cocoa
C85501	Brook	C85510	Red Sky
C85502	Torrent	C85633	White
C85506	Night Sky	C85636	Purple Torch
		C85638	Tile Blue

Vintage Select Fabrics

Luxurious Fabric surfaces with bright white acid-free and lignin-free core and backing.

Vintage 32" x 40" 4-ply
 17% 7% List
 50+ sheets 25-49 sheets 1-24 sheets

Item #	Color	Item #	Color	Item #	Color
C5558	Vintage Yellow	C5560	Black Shadow	C5632	Warm White
C5559	British Tan	C5561	Sahara Sand		



UltiBlack Crescent Select

100% virgin alpha-cellulose solid black core selects that are acid-free and lignin-free for surface, core and backing. Suitable for conservation framing. Featuring the industry's deepest and blackest core.

UltiBlack Select 32" x 40" 4-ply
 17% 7% List
 50+ sheets 25-49 sheets 1-24 sheets

Item #	Color	Item #	Color	Item #	Color
C9900	Baker's White	C9917	Forest Green	C9932	Fawn
C9901	Chalk	C9922	Flag Blue	C9934	Putty
C9902	White Art	C9923	Blue Night	C9935	York
C9904	Pure White	C9926	All American	C9938	Kensington
C9905	Dove		Red	C9940	Gladstone
C9906	Off White	C9927	Brick	C9942	Dark Shale
C9912	Sandstone	C9928	Cabernet	C9944	Jet Black
C9916	Mocha Green	C9930	Plum	C9948	Black Belt

UltiBlack Select 32" x 40" 4-ply
 17% 7% List
 50+ sheets 25-49 sheets 1-24 sheets

Item #	Color	Item #	Color
C5579	Etched Black	C9945	Silver
C9910	Antwerpen	C9946	Rose
C9911	Bruxelles	C9947	Spanish Gold

UltiBlack Select Etched Metals 32" x 40" 4-ply
 17% 7% List
 50+ sheets 25-49 sheets 1-24 sheets

Item #	Color	Item #	Color
C9949	Gunmetal	C9950	Oil-Rubbed Bronze

UltiBlack Select 32" x 40" 4-ply
 17% 7% List
 50+ sheets 25-49 sheets 1-24 sheets

Item #	Color	Item #	Color
C69745	Football (UltiBlack)	C69746	Basketball (UltiBlack)

UltiBlack Select 40" x 60" 4-ply
 17% 7% List
 50+ sheets 25-49 sheets 1-24 sheets

Item #	Color	Item #	Color
C89901	Chalk	C89944	Jet Black
C89940	Gladstone	C89948	Black Belt

UltiBlack Select 40" x 60" 4-ply
 17% 7% List
 50+ sheets 25-49 sheets 1-24 sheets

Item #	Color
C85579	Etched Black

Moorman Fabric:

Provide your customers with the best range of exquisite, unique fabric matboards in the industry. Instantly add texture and drama to any custom framed piece. The Moorman collection offers unparalleled quality, color and style for sophisticated and refined matting. The line's rich textures complement both traditional and contemporary decor.

Moorman Black Core Suedes 32" x 40" 4-ply
 17% 7% List
 50+ sheets 25-49 sheets 1-24 sheets

Item #	Color	Item #	Color	Item #	Color
C67106	Antelope	C67113	Marine Blue	C67139	Anthracite
C67111	Shamrock Green	C67114	Carbon Black		

Moorman Linens 32" x 40" 4-ply
 17% 7% List
 50+ sheets 25-49 sheets 1-24 sheets

Item #	Color	Item #	Color	Item #	Color	Item #	Color
C7501	Vink	C7531	Light Gray	C7551	Flax	C7569	Loden Gn
	Tweed	C7533	Med Blue	C7553	Edelweiss	C7571	Delft Brown
C7513	Forest Green	C7536	Blue Green	C7554	North Sea	C7572	Worn Gray
		C7537	Light Moss	C7556	Dutch Choc.	C7573	Brindle Bn
C7517	Dark Rose	C7540	Light Beige	C7557	Topiary	C7580	Burgundy
C7518	Royal Blue	C7541	Silver Gray	C7560	Basque	C7581	Jewel Blue
C7519	White	C7542	Red Carpet	C7564	Maroon	C7582	Lotus
C7520	Med Gray	C7543	Dk Mauve	C7565	Vintage	C7583	Scroll
C7521	Blue Gray	C7548	True Blue		Ruby	C7584	Havana
C7522	Black	C7549	Jasper Brown	C7566	Amethyst	C7586	Sumi
C7526	Cream	C7550	Smokey Hill	C7567	Ultramarine Blue	C7588	Khaki
C7529	Med Brn		Hill			C7597	Off White

Moorman Linens 40" x 60" 4-ply
 17% 7% List
 50+ sheets 25-49 sheets 1-24 sheets

Item #	Color	Item #	Color	Item #	Color
C87513	Forest Green	C87542	Red Carpet	C87560	Basque
C87518	Royal Blue	C87548	True Blue	C87571	Delft Brown
C87519	White	C87549	Jasper Brown	C87572	Worn Gray
C87522	Black	C87550	Smokey Hill	C87573	Brindle Brown
C87526	Cream	C87551	Flax	C87581	Jewel Blue
C87529	Medium Brown	C87553	Edelweiss	C87582	Lotus
C87540	Light Beige	C87556	Dutch Choc	C87586	Sumi
C87541	Silver Gray	C87557	Topiary	C87597	Off White

Moorman Natural Linen 32" x 40" 4-ply
 17% 7% List
 50+ sheets 25-49 sheets 1-24 sheets

Item #	Color	Item #	Color	Item #	Color
C7700	Warm White	C7703	Willow	C7706	Harvest
C7701	Canvas	C7704	Lagoon	C7707	Midnight
C7702	Parchment	C7705	Stone		

Moorman Natural Linen 40" x 60" 4-ply
 17% 7% List
 50+ sheets 25-49 sheets 1-24 sheets

Item #	Color	Item #	Color
C87700	Warm White	C87706	Harvest
C87705	Stone	C87707	Midnight

Moorman Sheer Silk 32" x 40" 4-ply
 17% 7% List
 50+ sheets 25-49 sheets 1-24 sheets

Item #	Color	Item #	Color
C7801	Antique White	C7808	Green

Moorman Shimmer Wovens 32" x 40" 4-ply
 17% 7% List
 50+ sheets 25-49 sheets 1-24 sheets

Item #	Color	Item #	Color	Item #	Color
C7310	Icicle	C7312	Mint Julep	C7314	Stardust
C7311	Golden Moon	C7313	Praline	C7315	Blue Galaxy



Moorman Suedes 32" x 40" 4-ply
 17% 7% List
 50+ sheets 25-49 sheets 1-24 sheets

Item #	Color	Item #	Color	Item #	Color
C7100	Moutarde	C7133	Dusty Green	C7168	Graphite
C7101	Perle	C7134	Asparagus	C7180	White
C7102	Dune	C7136	Le Beige	C7181	Sunset
C7104	Chamois	C7139	Anthracite	C7182	Bronze
C7105	Dark Rust	C7141	Platinum	C7183	Moccasin
C7106	Antelope	C7155	Wildgrass	C7184	Cinnamon
C7109	Taupe	C7156	Summer Sky	C7185	Chambord
C7111	Shamrock Green	C7157	Cattail	C7186	French Lavender
C7112	Bordeaux	C7158	Storm Gray	C7187	Celestial
C7113	Marine Blue	C7159	Cottage Stone	C7190	Olive
C7114	Carbon Black	C7160	Ember	C7193	Tumbleweed
C7115	Moka	C7163	Rattan	C7194	Garnet
C7116	Chinese Red	C7164	Meadow	C7195	Sapphire
C7120	Polaris	C7165	Evergreen	C7196	Teal
C7127	Milkweed	C7166	Navy	C7199	Spruce
C7128	Off White	C7167	Boulder		
C7132	Whisper				

Moorman Suedes 40" x 60" 4-ply
 17% 7% List
 50+ sheets 25-49 sheets 1-24 sheets

Item #	Color	Item #	Color	Item #	Color
C87100	Moutarde	C87127	Milkweed	C87158	Storm Gray
C87101	Perle	C87128	Off White	C87163	Rattan
C87102	Dune	C87132	Whisper	C87166	Navy
C87104	Chamois	C87133	Dusty Green	C87168	Graphite
C87105	Dark Rust	C87134	Asparagus	C87180	White
C87106	Antelope	C87135	Pine Green	C87183	Moccasin
C87111	Shamrock Green	C87136	Le Beige	C87184	Cinnamon
C87112	Bordeaux	C87139	Anthracite	C87185	Chambord
C87113	Marine Blue	C87155	Wildgrass	C87190	Olive
C87114	Carbon Black	C87157	Cattail	C87193	Tumbleweed
C87116	Chinese Red			C87195	Sapphire

Paper Mat Boards: Tones & Flannels

Decorative Matboards, with a light cream core, provide an unrivaled range of colors and textures for traditional non-conservation framing. Used for Decorative framing & general presentations, Open end reproductions or Posters & decorative art.

Paper Mats 32" x 40" 4-ply
 20% 17% 7% List
 Full Pack 50+ sheets 25-49 sheets 1-24 sheets

Item #	Color
C33	White & Cream Smooth

Paper Mats 32" x 40" 4-ply
 20% 17% 7% List
 Full Pack 50+ sheets 25-49 sheets 1-24 sheets

Item #	Color
C34	White & Cream Pebble

Paper Mats 32" x 40" 4-ply 25/pack
 20% 17% 7% List
 Full Pack 50+ sheets 25-49 sheets 1-24 sheets

Item #	Color	Item #	Color	Item #	Color	Item #	Color
C900	Red	C961	Cream	C987	Palm Beach	C1024	Dusty Blue
C902	Yellow	C962	French Gray		White	C1025	Medium Gray
C905	Violet	C968	Old Gold	C988	Williamsburg	C1027	Silver Gray
C907	Wine	C970	Gold		Green	C1028	Spice Ivory
C909	English Rose	C972	French Blue	C989	Raven Black	C1029	Wheat
C915	Fog	C974	Dawn Gray	C993	Kelly Green	C1032	Dark Olive
C916	Autumn Mist	C976	Bar Harbor	C994	Chamois Gold	C1033	Dark Ash
C918	Very White		Gray	C997	Sable	C1038	Maroon
C919	Ivy Green	C977	Newport Blue	C1008	Ivory	C1039	Auburn
C921A	Smooth Blk	C978	Congo Green	C1009	Light Jonquil	C1040	Classic Brown
C924	Dark Gray	C979	Dusk	C1014	Olde Grey	C1042	Williamsburg
C934	Pearl	C983	Saddle Tan	C1015	Grey Violet		Red
C935	Copley Gray	C984	Oak Brown	C1016	Concord	C1045	Grass Green
C939	Dark Green	C985	Pyro Brown	C1019	Photo Grey	C1047	Williamsburg
C948	Sand	C986	Tampico Brown				Blue
C960	White						

Paper Mats 32" x 40" 4-ply 25/pack
 (continued)
 20% 17% 7% List
 Full Pack 50+ sheets 25-49 sheets 1-24 sheets

Item #	Color	Item #	Color	Item #	Color	Item #	Color
C1051	Olde Tan	C1082	Marine Blue	C3293	Antique White	C3344	Manor Black
C1053	Delft Blue	C1084	Avocado	C3297	Arctic White	C3352	Light Umbria
C1054	Baltic Blue	C1085	Rust	C3300	Alabaster	C3354	Winter White
C1057	Redwood	C1088	Mist	C3311	Granite	C3357	Aqua Green
C1061	Sandstone	C1089	Saunterne	C3319	Topaz	C3358	Indigo
C1073	Biscay Blue	C1090	Pewter	C3320	Saffron	C3359	Sundown
C1076	Las Cruces	C1092	Azure	C3323	Real Teal		Shadow
	Purple	C1095	Antique Buff	C3325	Mandarin	C3360	China Blue
C1077	Burnt Orange	C1096	Sepia	C3326	Lapis	C3380	Hay
C1078	Madagascar	C1097	Fudge	C3331	Sage	C3387	Rattan
	Pink	C3214	Chinese Red	C3333	Black Watch	C3921	Black/White
C1080	Bimini Blue	C3290	Snow White	C3342	Midnight		Pebble
C1081	Volcano Blue	C3291	French Buff		Green		
				C3343	Off White		

Paper Mats 32" x 40" 4-ply 25/pack
 20% 17% 7% List
 Full Pack 50+ sheets 25-49 sheets 1-24 sheets

Item #	Color	Item #	Color	Item #	Color
C1000	Pompano	C1001	Moss Point	C1002	Mist Gray
	Beach White		Green		

Paper Mats 32" x 40" 4-ply
 17% 7% List
 50+ sheets 25-49 sheets 1-24 sheets

Item #	Color	Item #	Color
C964	Silver Florentine	C967	Medium Gold Florentine

Paper Mats 32" x 40" 4-ply
 17% 7% List
 50+ sheets 25-49 sheets 1-24 sheets

Item #	Color
C3703	Gunmetal

Paper Mats 32" x 40" 4-ply
 17% 7% List
 50+ sheets 25-49 sheets 1-24 sheets

Item #	Color
C4140	White

Paper Mats 40" x 60" 4-ply
 17% 7% List
 50+ sheets 25-49 sheets 1-24 sheets

Item #	Color	Item #	Color	Item #	Color
C831	Smooth Black	C8983	Saddle Tan	C81088	Mist
C8900	Red	C8987	Palm Beach White	C81090	Pewter
C8918	Very White	C8988	Williamsburg Grn	C81096	Sepia
C8924	Dark Gray	C8989	Raven Black	C83214	Chinese Red
C8934	Pearl	C8994	Chamois Gold	C83291	French Buff
C8948	Sand	C8997	Sable	C83293	Antique White
C8961	Cream	C81027	Silver Gray	C83297	Arctic White
C8962	French Gray	C81028	Spice Ivory	C83300	Alabaster
C8968	Old Gold	C81038	Maroon	C83326	Lapis
C8969	Silver	C81051	Olde Tan	C83331	Sage
C8974	Dawn Gray	C81081	Volcano Blue	C83344	Manor Black
C8977	Newport Blue	C81085	Rust		
C8978	Congo Green				



Black Cores

Add contrast and drama to non-conservation framing. Decorative facing papers. Solid black core and backing. Exclusive non-scuff backing paper. Buffered pH neutral.

Black Cores 32" x 40" 4-ply
 17% 7% List
 50+ sheets 25-49 sheets 1-24 sheets

Item #	Color	Item #	Color	Item #	Color
C6915	Fog	C61025	Medium Gray	C61073	Biscay Blue
C6977	Newport Blue	C61027	Silver Gray	C61088	Mist
C6984	Oak Brown	C61028	Spice Ivory	C63297	Arctic White
C6988	Williamsburg Grn	C61029	Wheat	C63300	Alabaster
C6989	Raven Black	C61032	Dark Olive	C63311	Granite
C61019	Photo Grey	C61033	Dark Ash	C63326	Lapis
C61023	Crimson	C61038	Maroon	C63344	Manor Black

Black Cores 40" x 60" 4-ply
 17% 7% List
 50+ sheets 25-49 sheets 1-24 sheets

Item #	Color	Item #	Color
C86989	Raven Black	C863297	Arctic White

Rag Mat: Museum

RagMat's properties faithfully adhere to the requirements of conservators in museums and libraries throughout the world. Crescent's entire line of cotton RagMat, the industry's most trusted brand of cotton rag matboard, is still produced following the time-honored practice of making paper from cotton fiber. Rag Mat is the only matting backed by a *limited lifetime warranty*.

Cotton RagMat is Pure and Environmentally-Friendly

Cotton is nature's purest form of cellulose. It is inherently free of lignin, acid and other non-cellulose contaminants found in wood pulp. Cotton fiber pulp is reliable, sturdy and far superior to bleached, chemically processed wood pulp. Cotton has a natural, lasting brightness that does not require the high level of bleaching agents typically used to whiten chemically processed wood pulp boards.

Cotton RagMat is Natural

RagMat Museum Solids, RagMat Solids and RagMat meet all of the stringent standards of conservation professionals.

Cotton RagMat is Time Tested

For centuries, cotton rag paper, prized for strength, purity and stability, has been the choice of artists, composers, writers and printers. Virtually all museums and libraries rely on cotton rag matboard.

Cotton RagMat is Strong

The long flat fibers of natural cotton pulp intertwine, creating a strong, resilient matboard and more durable than bleached chemical wood pulp fiber. RagMat Museum Solids, RagMat Solids, and the core and backing of RagMat are all made from 100% virgin cotton linter pulp. This assures unequal cleanliness and purity.

Cotton RagMat is Colorful

Only the finest pigments are used to create the colors of our RagMat products. All of these colorants are designed to meet the highest levels of conservation standards. They are bleed resistant so that no color leaches onto the artwork. They provide maximum fade resistance, meeting the most stringent requirements for light-fastness. They are designed for consistency, avoiding color shifts within a production run.

Premium quality conservation surfaces on 100% cotton white core & backing papers.
Rag Mat 32" x 40" 4-ply
 17% 7% List
 50+ sheets 25-49 sheets 1-24 sheets

Item #	Color	Item #	Color	Item #	Color	Item #	Color
C1420	Cloud	C1526	Tandoori	C1553	Bar Harbor	C1564	Oak Brn
C1421	Satin	C1528	Napa Wine		Gray	C1565	Suntan
C1423	Cloth	C1545	Light Umbria	C1554	Williamsburg	C1566	Sandstone
C1427	Chive	C1548	Ashen		Green	C1567	Sand
C1429	Lake	C1550	Newport	C1555	Avocado	C1570	French Buff
C1431	Ink Blue		Blue	C1560	Rust	C1571	Palm
C1433	Shade	C1552	Biscay Blue	C1561	Sepia		Beach White
C1517	Ra			C1562	Sable	C1572	Mist

Rag Mat 32" x 40" 4-ply
 (continued)
 17% 7% List
 50+ sheets 25-49 sheets 1-24 sheets

Item #	Color	Item #	Color	Item #	Color	Item #	Color
C1573	Pearl	C1607	Brite White	C1645	Cherub Pink	C1672	Barely Pink
C1574	Dawn Gray	C1608	Cream	C1646	Sky Blue	C1673	Really Red
C1575	Copley Gray	C1609	Ant White	C1647	Patriot Blue	C1678	French
C1576	Dark Gray	C1610	White	C1648	Ultramarine		Jonquil
C1577	Raven Black	C1613	Very White	C1649	Naples Yellow	C1679	Wild Basil
C1578	Williamsburg Blue	C1619	Topaz	C1650	Warm White	C1683	Sauterne
		C1624	Periwinkle	C1651	Flaxen	C1685	Moonlight
C1582	Ant. Buff		Blue	C1652	Auburn	C1688	Whisper
C1583	Olde Tan	C1626	Lapis	C1653	Maroon		White
C1584	Nutmeg	C1627	Cerise	C1654	Laurel Green	C1689	Sandstorm
C1588	Ivory	C1631	Sage	C1656	Country Blue	C1690	Olive Bronze
C1594	Olde Grey	C1633	Black Watch	C1659	Blue Belle	C1693	Sherwood
C1595	Grey Violet	C1634	Fog	C1660	Imperial Blue		Green
C1599	Dusty Blue	C1636	Alabaster	C1662	Espresso	C1768	Old Gold
C1600	Med Gray	C1639	Amethyst	C1663	Chamois		
C1602	Silver Gray	C1640	Purple		Gold		
C1603	Spice Ivory		Wildflower	C1664	Script White		
C1604	Wheat	C1641	Malachite	C1665	Barely Blue		
C1605	Pastel Pink	C1643	Garnet	C1666	Sheer Blue		
C1606	Off White	C1644	Azalea				

Rag Mat 40" x 60" 4-ply
 Premium quality conservation surfaces on 100% cotton white core & backing papers.
 17% 7% List
 50+ sheets 25-49 sheets 1-24 sheets

Item #	Color	Item #	Color	Item #	Color
C81550	Newport Blue	C81583	Olde Tan	C81613	Very White
C81554	Williamsburg Green	C81584	Nutmeg	C81619	Topaz
		C81588	Ivory	C81625	Crimson
C81562	Sable	C81602	Silver Gray	C81626	Lapis
C81571	Palm Beach White	C81603	Spice Ivory	C81631	Sage
		C81606	Off White	C81647	Patriot Blue
C81572	Mist	C81607	Brite White	C81653	Maroon
C81576	Dark Gray	C81609	Antique White	C81664	Script White
C81577	Raven Black	C81610	White	C81689	Sandstorm
C81578	Williamsburg Blue	C81612	True Red		

Rag Mat Museum 32" x 40" 4-ply
 100% cotton rag.
 17% 7% List
 50+ sheets 25-49 sheets 1-24 sheets

Item #	Color	Item #	Color	Item #	Color
C1112	Soft White	C1170	Cool White	C1188	Winter White
C1126	Sand Dollar	C1171	Silk	C2253	White
				C2259	Antique White

Rag Mat Museum 32" x 40" 4-ply
 100% cotton rag.
 17% 7% List
 50+ sheets 25-49 sheets 1-24 sheets

Item #	Color	Item #	Color	Item #	Color
C1100	Archival Mist	C1117	Gray	C1173	Soft Cream
C1101	Neutral Gray	C1121	Inverness	C1174	Beige
C1102	Vintage Gray	C1122	Stratford	C1175	Clay
C1104	Antique Tan	C1125	Shetland	C1176	Suntan
C1105	Desert Sand	C1127	Sprout	C1186	Cool Gray
C1106	Antique Gray	C1128	Shoreline	C1187	Essential Gray
C1114	Almond	C1129	Bluff	C2255	Cream
		C1133	Briar		



Rag Mat Museum 32" x 40" 4-ply			
100% cotton rag.	17%	7%	List
50+ sheets	25-49 sheets	1-24 sheets	

Item #	Color	Item #	Color	Item #	Color
C1115	Black	C1137	Fieldstone	C1184	Sable
C1123	New Castle	C1177	Brownstone	C1189	Sanguine
C1136	Loam			C2296	Optic Black

Rag Mat Museum 40" x 60" 4-ply			
100% cotton rag.	17%	7%	List
50+ sheets	25-49 sheets	1-24 sheets	

Item #	Color	Item #	Color	Item #	Color
C2260	Antique White	C81112	Soft White	C81126	Sand Dollar
C2262	White			C81188	Winter White

Rag Mat Museum 40" x 60" 4-ply			
100% cotton rag.	17%	7%	List
50+ sheets	25-49 sheets	1-24 sheets	

Item #	Color	Item #	Color	Item #	Color
C81104	Antique Tan	C81105	Desert Sand	C81106	Antique Gray

Rag Mat Museum 40" x 60" 4-ply			
100% cotton rag.	17%	7%	List
50+ sheets	25-49 sheets	1-24 sheets	

Item #	Color	Item #	Color	Item #	Color
C2261	Cream	C81114	Almond	C81121	Inverness

Rag Mat Museum 40" x 60" 4-ply			
100% cotton rag.	17%	7%	List
50+ sheets	25-49 sheets	1-24 sheets	

Item #	Color
C81115	Black

Rag Mat Museum 32" x 40" 6-ply			
100% cotton rag.	17%	7%	List
50+ sheets	25-49 sheets	1-24 sheets	

Item #	Color
C1536	White

Rag Mat Museum 32" x 40" 8-ply			
100% cotton rag.	17%	7%	List
50+ sheets	25-49 sheets	1-24 sheets	

Item #	Color	Item #	Color	Item #	Color
C2238	White	C21112	Soft White	C21188	Winter White
C2239	Antique White	C21126	Sand Dollar		

Rag Mat Museum 32" x 40" 8-ply			
100% cotton rag.	17%	7%	List
50+ sheets	25-49 sheets	1-24 sheets	

Item #	Color	Item #	Color	Item #	Color
C21104	Antique Tan	C21106	Antique Gray	C22255	Cream

Rag Mat Museum 32" x 40" 8-ply			
100% cotton rag.	17%	7%	List
50+ sheets	25-49 sheets	1-24 sheets	

Item #	Color
C21115	Black

Rag Mat Museum 40" x 60" 8-ply			
100% cotton rag.	17%	7%	List
50+ sheets	25-49 sheets	1-24 sheets	

Item #	Color	Item #	Color	Item #	Color
C2268	White	C82239	Antique White	C821112	Soft White
				C821188	Winter White

Rag Mat Museum 40" x 60" 8-ply			
100% cotton rag.	17%	7%	List
50+ sheets	25-49 sheets	1-24 sheets	

Item #	Color
C821115	Black

Rag Mat Museum Mounting Boards 32" x 40" 2-ply 25/pack			
20% 100% cotton rag	17%	7%	List
Full Pack	50+ sheets	25-49 sheets	1-24 sheets

Item #	Color	Item #	Color
C1150	White	C1152	Cream

Rag Mat Museum Mounting Boards 32" x 40" 4-ply			
100% cotton rag.	17%	7%	List
50+ sheets	25-49 sheets	1-24 sheets	

Item #	Color	Item #	Color
C1153	White	C1159	Antique White

Rag Mat Museum Mounting Boards 40" x 60" 4-ply			
100% cotton rag.	17%	7%	List
50+ sheets	25-49 sheets	1-24 sheets	

Item #	Color
C1162	White

Rag Mat Museum Duplex 2-sided Matting & Mounting Board 32" x 40" 4-ply			
100% cotton rag.	17%	7%	List
50+ sheets	25-49 sheets	1-24 sheets	

Item #	Color	Item #	Color
C1530	White/Antique White	C1531	Off White/Cream

Rag Mat Antiquarian 32" x 40" 4-ply			
100% cotton rag.	17%	7%	List
50+ sheets	25-49 sheets	1-24 sheets	

Item #	Color	Item #	Color
C1703	Foxhunt Green	C1709	Light Umbria
C1704	Ashen	C1710	Dark Umbria
C1705	Antique Ivory	C1711	Black Walnut
C1708	Hazlenut	C1721	Black
		C1723	Lapis

Rag Mat Noir 32" x 40" 4-ply			
100% cotton rag.	17%	7%	List
50+ sheets	25-49 sheets	1-24 sheets	

Item #	Color	Item #	Color	Item #	Color
C61571	Palm Beach White	C61610	White	C61689	Sandstorm
C61574	Dawn Gray	C61662	Espresso	C61690	Olive Bronze
C61603	Spice Ivory			C61704	Ashen

Rag Mat Barrier Paper 32" x 40" 1-ply 0.015" 100/pack			
20% 100% cotton rag	17%	7%	List
Full Pack	50+ sheets	25-49 sheets	1-24 sheets

Item #	Color
C1515	Acid-Free Off White Barrier Paper

Rag Mat Barrier Paper 32" x 100" 1-ply 0.015"	
100% cotton rag	Price per Roll

Item #	Color
C1505	Acid-Free Off White Barrier Paper

Rag Mat Museum OVERSIZED 4-ply					
100% cotton rag					

Item #	Color	Size	Packaging	Qty/Pack	Full box Price	1 Sheet
C2263	White	48x72		20		
C2269	Ant Wht	48x72	1 sheet price includes	20		
C2273	White	48x96		1 sheet #204	10	
C2275	Black	48x96	48"x96" foamboard	15		
C2279	Antique	48x96		10		
C2283	White	60x104	1 sheet price includes	5		
C2289	Antique	60x104		1 sheet #208	5	
	White		60"x120" foamboard			

* Full Box Price DOES NOT include foamboard



Rag Mat Museum OVERSIZED 8-ply
100% cotton rag

Item #	Color	Size	Packaging	Qty/Pack	Full box Price	1 Sheet
C22263	White	48x72	1 sheet price includes foamboard	10	SAVE 20% Full box Price	1 Sheet
C22273	White	48x96		5		

* Full Box Price DOES NOT include foamboard

WhiteCore Basics

A non-conservation white core matboard, provides the aesthetic and design benefits of a bright-white bevel. Use for decorative framing, general presentations, open end reproductions, posters and decorative art.

WhiteCore 32" x 40" 4-ply
17% 7% List
50+ sheets 25-49 sheets 1-24 sheets

Item #	Color	Item #	Color	Item #	Color
CSRM902	Yellow	CSRM1001	Moss Point Green	CSRM1084	Avocado
CSRM915	Fog	CSRM1008	Ivory	CSRM1088	Mist
CSRM918	Very White	CSRM1014	Olde Grey	CSRM1089	Sauterne
CSRM919	Ivy Green	CSRM1015	Grey Violet	CSRM1096	Sepia
CSRM921	Smooth Black	CSRM1016	Concord	CSRM3214	Chinese Red
CSRM924	Dark Gray	CSRM1019	Photo Grey	CSRM3290	Snow White
CSRM934	Pearl	CSRM1023	Crimson	CSRM3291	French Buff
CSRM939	Dark Green	CSRM1025	Medium Gray	CSRM3293	Antique White
CSRM948	Sand	CSRM1027	Silver Gray	CSRM3297	Arctic White
CSRM961	Cream	CSRM1028	Spice Ivory	CSRM3300	Alabaster
CSRM972	French Blue	CSRM1029	Wheat	CSRM3319	Topaz
CSRM976	Bar Harbor Gray	CSRM1032	Dark Olive	CSRM3325	Mandarin
CSRM977	Newport Blue	CSRM1038	Maroon	CSRM3326	Lapis
CSRM978	Congo Green	CSRM1039	Auburn	CSRM3331	Sage
CSRM979	Dusk	CSRM1040	Classic Brown	CSRM3333	Black Watch
CSRM984	Oak Brown	CSRM1042	Williamsburg Red	CSRM3400	Baker's White
CSRM985	Pyro Brown	CSRM1045	Grass Green	CSRM3401	Chalk
CSRM986	Tampico Brown	CSRM1047	Williamsburg Blue	CSRM3403	Dove
CSRM987	Palm Beach White	CSRM1051	Olde Tan	CSRM3417	Flag Blue
CSRM988	Williamsburg Green	CSRM1053	Delft Blue	CSRM3420	All American Red
		CSRM1054	Baltic Blue		Red
CSRM989	Raven Black	CSRM1057	Redwood	CSRM3423	Jet Black
CSRM994	Chamois Gold	CSRM1073	Biscay Blue		
CSRM997	Sable	CSRM1076	Las Cruces Purple		
CSRM1000	Pompano Beach White	CSRM1081	Volcano Blue		
		CSRM1082	Marine Blue		

WhiteCore 32" x 40" 4-ply
17% 7% List
50+ sheets 25-49 sheets 1-24 sheets

Item #	Color	Item #	Color
CSRM968	Old Gold	CSRM3437	Antwerpen
CSRM969	Silver	CSRM3438	Bruxelles

WhiteCore 40" x 60" 4-ply
17% 7% List
50+ sheets 25-49 sheets 1-24 sheets

Item #	Color	Item #	Color
CSRM8921	Smooth Black	CSRM83293	Antique White
CSRM8977	Newport Blue	CSRM83297	Arctic White
CSRM8987	Palm Breach White	CSRM83400	Baker's White
CSRM8988	Williamsburg Green	CSRM83401	Chalk
CSRM8989	Raven Black	CSRM83417	Flag Blue
CSRM81027	Silver Gray	CSRM83420	All American Red
CSRM81028	Spice Ivory	CSRM83423	Jet Black
CSRM81088	Mist		

WhiteCore 40" x 60" 4-ply
17% 7% List
50+ sheets 25-49 sheets 1-24 sheets

Item #	Color
CSRM83437	Antwerpen

Faux Marble

Decorative surface on premium white core and backing. Buffered, pH neutral.

Faux Marble 32" x 40" 4-ply
17% 7% List
50+ sheets 25-49 sheets 1-24 sheets

Item #	Color
C4404	Black Marble

Couture

SPECIAL ORDER

Exclusive gallery collection of uniquely designed premium Rag Mat 100% cotton solid colored core and backing. Acid-free and lignin-free surface, core and backing.

Couture 32" x 40" 4-ply

Item #	Color	Item #	Color
C1300	Spun Tungsten	C1303	Black Lacquer
C1301	Spun Platinum	C1304	Grey Pebbles
C1302	Silver Jute	C1305	Black Pebbles

Couture 32" x 40" 4-ply

Item #	Color	Item #	Color
C1308	Urban Gray	C1311	Mahogany Leather
C1309	Silver Birch	C1312	Russet Leather
C1310	Aged Copper		

Couture 32" x 40" 4-ply

Item #	Color	Item #	Color
C1313	Silver Leaf	C1314	Gold Leaf

#COUCNRRK: Couture corner kit includes the above 14 styles. Shipped and billed directly from Crescent. Freight additional. \$70 refund after your purchase of 2 of these mats. Show Crescent copy of our invoice.

Bainbridge®

AlphaMat Artcare

Artcare products feature the patented MicroChamber® technology that provides a preventative conservation protection unavailable with other matboard. A unique combination of zeolites and buffers traps and neutralizes oxidizing gasses, other pre-acidic gasses, and degradative by-products - giving Artcare boards the ability to actively protect art and photographs

against attack by external pollutants and internal vices.

Alphamat is made to exacting 100% archival standards using virgin alpha-cellulose fiber. Produced with pigments, not dyes and is fade and bleed resistant to insure lasting colors for the life of your customers' art. All cores are solid white archival and lignin-free for clean consistent cut bevels.

AlphaMat Artcare
32" x 40" 4-ply 25/pack

20%	17%	7%	List
Full Pack	50+ sheets	25-49 sheets	1-24 sheets

AlphaMat Artcare Specialties:
American Vintage 32" x 40" 4-ply

17%	7%	List
50+ sheets	25-49 sheets	1-24 sheets

Item #	Color	Item #	Color	Item #	Color
B8013	Matador	B8429	Orchid	B8512	Sorrel
B8052	Precious Pink	B8440	Aubergine	B8513	Celadon
B8055	Ardent Blue	B8441	Chaps	B8514	Sonora
B8056	Balmy Blue	B8442	Kona	B8515	Dover Grey
B8105	Blue Iris	B8443	Teak	B8516	Pampas
B8107	Peacock	B8444	Pecan	B8517	Ivory Black
B8108	Sherry	B8445	Fiddlehead	B8518	Ash
B8151	Palm	B8446	Raffia	B8519	Snowflake
B8153	Jute	B8447	Black Spruce	B8520	Talc
B8180	Mocha	B8448	Jalapeno	B8521	Fairfield White
B8181	Matte Black	B8450	Denim Blue	B8522	Cobblestone
B8182	Rainforest Grn	B8451	Mulberry	B8526	Indigo
B8183	Darkest Blue	B8453	Cayenne	B8527	Almandine
B8184	Black Cherry	B8454	Marigold	B8528	Garnet
B8186	Light Stone	B8455	Maize	B8531	Spice
B8192	Fiery Red	B8456	Fog	B8534	Flemish Blue
B8260	Ice White	B8458	Smoke	B8535	Moroccan Sand
B8261	Goosedown	B8460	Quaker Grey	B8536	Heather Mist
B8262	Polar White	B8461	Gun Metal	B8539	Briarwood
B8263	Beeswax	B8466	Frost	B8540	Tartan Green
B8264	Wild Olive	B8467	French White	B8545	Catawba
B8265	Tabasco	B8468	Medieval Forest	B8551	Baltic Green
B8267	Crystal Blue	B8470	Etruscan Bronze	B8552	Carmine
B8268	Moonrock	B8471	Dynasty Celadon	B8555	Nimbus
B8269	Claret	B8473	Florentine Lapis	B8556	Kirkwood
B8270	Clementine	B8474	Persian Sapphire	B8560	Sultan Sand
B8271	Dreamweaver	B8475	Olympian Blue	B8563	Taupe
B8272	Goldenrod	B8478	Romanesque	B8564	Powder Rose
B8273	Beryl		Grape	B8565	Olde Rose
B8274	Dawn	B8479	Imperial Plum	B8567	Dusk Grey
B8275	Dried Sage	B8483	Baroque Ruby	B8570	Ice Blue
B8276	Paloma	B8484	Venetian Garnet	B8571	Hunter Green
B8277	Pagoda	B8485	Renaissance	B8572	Blue Spruce
B8278	Bijou		Gold	B8573	Tapestry
B8401	Biscotti	B8486	Arabian White	B8574	Sapphire
B8409	Amber	B8487	Palomino	B8583	Pale Mauve
B8412	Green Olive	B8488	Sand Dune	B8584	Periwinkle
B8417	Venetian Blue	B8500	Shell	B8585	Jonquil
B8418	Charleston Grn	B8503	Chamois	B8586	Iris
B8420	Softly Pink	B8504	Shadow Blue	B8589	Teal Blue
B8424	Chameleon	B8505	Teal Grey	B8591	Right Red
B8425	Sea Green	B8506	Tuscan Brown	B8592	Bordeaux
B8426	Parakeet	B8509	Malacca	B8593	Steel Grey
B8428	Papaya	B8510	Annapolis Blue	B8597	Flagstone
		B8511	Sea Mist		

Item #	Color	Item #	Color
B608155	Tornado	B608512	Java
B608181	Black Denim		

AlphaMat Artcare Specialties:
Animation 32" x 40" 4-ply 25 pack

20%	17%	7%	List
Full Pack	50+ sheets	25-49 sheets	1-24 sheets

Item #	Color	Item #	Color
B8027	Mango	B8043	Medium Marine
B8037	Lime	B8060	Urban Grey
B8042	Light Marine	B8061	Urban Black
		B8063	Desert

AlphaMat Artcare Specialties:
Antique Metals 32" x 40" 4-ply

17%	7%	List
50+ sheets	25-49 sheets	1-24 sheets

Item #	Color
B998008	Gold Bullion

AlphaMat Artcare Specialties:
Color Core 32" x 40" 4-ply
 100% archival with distinctive colored bevel

17%	7%	List
50+ sheets	25-49 sheets	1-24 sheets

Item #	Color	Item #	Color
B8301	Ivory Black/Black Sable Core	B8315	Fairfield White/Black Sable Core
B8304	Flint/Black Sable Core	B8317	Steel Grey/Black Sable Core
B8305	Featherstone/Black Sable Core	B8318	Malacca/Black Sable Core
B8306	Matte White/Black Sable Core	B8319	Teal Grey/Black Sable Core
B8307	Frost/Black Sable Core	B8320	Taupe/Black Sable Core
B8308	Sea Mist/Black Sable Core	B8841	Ash/Photo Grey Core
B8313	Snowflake/Black Sable Core		

AlphaMat Artcare
40" x 60" 4-ply

17%	7%	List
50+ sheets	25-49 sheets	1-24 sheets

Item #	Color	Item #	Color	Item #	Color
BL8260	Ice White	BL8479	Imperial Plum	BL8520	Talc
BL8445	Fiddlehead	BL8505	Teal Grey	BL8526	Indigo
BL8448	Jalapeno	BL8506	Tuscan Brown	BL8527	Almandine
BL8450	Denim Blue	BL8509	Malacca	BL8540	Tartan Green
BL8462	Wheat	BL8515	Dover Grey	BL8570	Ice Blue
BL8465	Igloo	BL8517	Ivory Black		
BL8466	Frost	BL8519	Snowflake		

AlphaMat Artcare Specialties:
Color Core 40" x 60" 4-ply
 100% archival with distinctive colored bevel
 17% 7% List
50+ sheets 25-49 sheets 1-24 sheets

Item #	Color	Item #	Color
BL8301	Ivory Black/Black Sable Core	BL8313	Snowflake/Black Sable Core

AlphaMat Artcare Specialties:
Parchments 32" x 40" 4-ply
 Subtle embossings and formation mirror real-life textures
 17% 7% List
50+ sheets 25-49 sheets 1-24 sheets

Item #	Color
B8815	Muslin

AlphaMat Artcare Specialties:
Earthstones
 Classic granitized papers
32" x 40" 4-ply
 17% 7% List
50+ sheets 25-49 sheets 1-24 sheets

Item #	Color	Item #	Color	Item #	Color
B8140	Topaz	B8801	Featherstone	B8809	Feldspar
B8142	Azurite	B8802	Aztec Sand	B8812	Zinc
		B8805	Flint		

AlphaMat Artcare Specialties:
Precious Metals
 Genuine archival metallic finishes, in smooth and antiqued styles
32" x 40" 4-ply
 17% 7% List
50+ sheets 25-49 sheets 1-24 sheets

Item #	Color	Item #	Color	Item #	Color
B8002	Silver	B8010	Patina Copper	B8093	Real Red
B8003	Gold	B8012	Brushed Onyx	B8094	Patriot Blue
B8004	Warm Gold	B8014	Grey Quartz	B8096	Bronze
B8006	Brushed Silver	B8015	Smoky Topaz	B8097	Aluminum
B8007	Brushed Pale Gold	B8083	Golden Mocha		
		B8085	Nickel		
B8008	Brushed Gold	B8086	Brass Band		

AlphaMat Artcare Specialties:
Forged Iron
32" x 40" 4-ply
 17% 7% List
50+ sheets 25-49 sheets 1-24 sheets

Item #	Color
B468085	Forged Iron

AlphaMat Artcare Specialties:
Precious Metals - Color Core
 Genuine archival metallic finishes, in smooth and antiqued styles
32" x 40" 4-ply
 17% 7% List
50+ sheets 25-49 sheets 1-24 sheets

Item #	Color
B8321	Brushed Onyx/Sable Core

AlphaMat Artcare Specialties:
Heritage
 Elegant, rustic surface treatments add visual texture
32" x 40" 4-ply
 17% 7% List
50+ sheets 25-49 sheets 1-24 sheets

Item #	Color	Item #	Color
B108506	Chocolate Swirl	B848512	Empire Gold
B628504	Concrete	B878455	Apple Cider
B648522	Grey Cedar	B878503	Rococo Cream
B768528	Barnyard	B878526	Renaissance Blue
B848443	Antique Sienna	B878540	Gothic Green
B848483	Tudor Red	B878559	Victorian Cameo

AlphaMat Artcare Specialties:
Precious Metals - Color Core
 Genuine archival metallic finishes, in smooth and antiqued styles
40" x 60" 4-ply
 17% 7% List
50+ sheets 25-49 sheets 1-24 sheets

Item #	Color
BL8321	Brushed Onyx/Sable Core

AlphaMat Artcare Specialties:
Leathers 32" x 40" 4-ply
 Subtle embossings and formation mirror real-life textures
 17% 7% List
50+ sheets 25-49 sheets 1-24 sheets

Item #	Color	Item #	Color
B8254	Cowhide Leather	B8259	Sable Leather

Bainbridge®

AlphaMat Artcare Specialties: Sports
32" x 40" 4-ply
 17% 7% List
 50+ sheets 25-49 sheets 1-24 sheets

Item #	Color	Item #	Color
B8020	Red Rave	B8022	Lemondrop

AlphaMat Ultra 1/8" Thick Artcare
40" x 60"
 17% 7% List
 50+ sheets 25-49 sheets 1-24 sheets

Item #	Color	Item #	Color
BLTM8463V	Spanish White	BLTM8517	Ivory Black

AlphaMat Artcare Specialties: Tuscany
 The look of slate, for added dimension and personality
32" x 40" 4-ply
 17% 7% List
 50+ sheets 25-49 sheets 1-24 sheets

Item #	Color	Item #	Color
B928155	Fiori Grotto	B928158	Sole Grotto

AlphaMat Ultra 1/8" Thick Artcare Color Core
32" x 40"
 17% 7% List
 50+ sheets 25-49 sheets 1-24 sheets

Item #	Color
BTM8321V	Spanish White/Sable Core

AlphaMat Artcare Specialties
32" x 40" Double Thick
 17% 7% List
 50+ sheets 25-49 sheets 1-24 sheets

Item #	Color
BTM8012	Onyx

AlphaMat Ultra 1/8" Thick Artcare Color Core
40" x 60"
 17% 7% List
 50+ sheets 25-49 sheets 1-24 sheets

Item #	Color
BLTM8321V	Spanish White/Sable Core

Alphamount Artcare is a pure alpha cellulose mounting board that offers superior rigidity and a surface that is ideally suited for hinges and corner pockets. Incorporates the Artcare technology for added protection against external pollutants and internal vices.

AlphaMat Artcare Vellum
32" x 40" 4-ply
 20% Full Pack 17% 7% List
 50+ sheets 25-49 sheets 1-24 sheets

Item #	Color	Item #	Color	Item #	Color
B8155V	Fiori	B8162V	Fango	B8462V	Wheat
B8156V	Prato	B8431V	Antique	B8463V	Spanish White
B8157V	Verde	B8432V	Angora	B8464V	Matte White
B8158V	Sole	B8434V	Coal	B8465V	Igloo
B8159V	Mare	B8435V	Chrome	B8544V	Photo Grey
B8160V	Luna	B8437V	Clover	B8559V	Photo White
B8161V	Terra	B8438V	Chalk		

Alphamount Artcare Mounting Board
32" x 40" 2-ply
 17% 7% List
 50+ sheets 25-49 sheets 1-24 sheets

Item #	Color
B8732	White

Alphamount Artcare Mounting Board
32" x 40" 4-ply
 17% 7% List
 50+ sheets 25-49 sheets 1-24 sheets

Item #	Color
B8734	White

AlphaMat Artcare Vellum
40" x 60" 4-ply
 17% 7% List
 50+ sheets 25-49 sheets 1-24 sheets

Item #	Color	Item #	Color
BL8463V	Spanish White	BL8464V	Matte White
		BL8559V	Photo White

AlphaMat Ultra 1/8" Thick Artcare
32" x 40"
 17% 7% List
 50+ sheets 25-49 sheets 1-24 sheets

Item #	Color	Item #	Color	Item #	Color
BTM8463V	Spanish White	BTM8466	Frost	BTM8520	Talc
BTM8464V	Matte White	BTM8517	Ivory Black	BTM8559V	Photo White
BTM8465V	Igloo	BTM8519	Snowflake		

AlphaRag Artcare - 100% Cotton

Alpharag Artcare products feature the patented MicroChamber® technology that provides a preventative conservation protection unavailable with other matboard. A unique combination of zeolites and buffers traps and neutralizes oxidizing gasses, other pre-acidic gasses, and degradative by-products - giving Alpharag boards the ability to actively protect art and photographs against attack by external pollutants and internal vices.

Alpharag is made to exacting 100% archival standards using virgin alpha-cellulose fiber. Produced with pigments, not dyes and is fade and bleed resistant to insure lasting colors for the life of your customers' art. All cores are solid archival for clean consistent cut bevles.

Alpharag Artcare
32" x 40" 1-ply
 17% 7% List
 50+ sheets 25-49 sheets 1-24 sheets

Item #	Color
B8649	White

Alpharag Artcare
32" x 40" 2-ply 25/pack
 20% Full Pack 17% 50+ sheets 7% 25-49 sheets List 1-24 sheets

Item #	Color	Item #	Color
B8632	White	B8654	Pure White

Alpharag Artcare - Lights
32" x 40" 4-ply
 17% 50+ sheets 7% 25-49 sheets List 1-24 sheets

Item #	Color	Item #	Color	Item #	Color
B8642	Cream	B8664	Special Cream	B8667	Colonial Cream
B8643	Dove Grey	B8665	Tumbleweed	B8668	Ecru
B8645	Ivory	B8666	Sand	B8674	Stone
B8646	Khaki				

Alpharag Artcare - Lights
40" x 60" 4-ply
 17% 50+ sheets 7% 25-49 sheets List 1-24 sheets

Item #	Color
BL8667	Colonial Cream

Alpharag Artcare - Darks
32" x 40" 4-ply
 17% 50+ sheets 7% 25-49 sheets List 1-24 sheets

Item #	Color	Item #	Color	Item #	Color
B8629	Fresh Hay	B8669	Black Shadow	B8690	Toasted Wheat
B8644	Ebony	B8673	Deep Sage		(Naturals)
B8663	Natural Black	B8678	Coir		

Alpharag Artcare - Darks
40" x 60" 4-ply
 17% 50+ sheets 7% 25-49 sheets List 1-24 sheets

Item #	Color
BL8644	Ebony

Alpharag Artcare - Whites
32" x 40" 4-ply 25/pack
 20% Full Pack 17% 50+ sheets 7% 25-49 sheets List 1-24 sheets
\$21.31/sh

Item #	Color	Item #	Color	Item #	Color
B8634	White	B8647	Pearl White	B8656	Natural White
B8640	Antique White	B8655	Pure White	B8688	Glacier White

Alpharag Artcare - Whites
32" x 40" 8-ply
 17% 50+ sheets 7% 25-49 sheets List 1-24 sheets

Item #	Color	Item #	Color	Item #	Color
B8647.8	Pearl White	B8653	Pure White	B8660	White

Alpharag Artcare - Whites
40" x 60" 4-ply
 17% 50+ sheets 7% 25-49 sheets List 1-24 sheets

Item #	Color	Item #	Color	Item #	Color
BL8634	White	BL8647	Pearl White	BL8655	Pure White

Alpharag Artcare - Whites
40" x 60" 8-ply
 17% 50+ sheets 7% 25-49 sheets List 1-24 sheets

Item #	Color	Item #	Color
BL8634.8	White	BL8647.8	Pearl White

Artcare AlphaEssentials 100%
Alpha Cellulose Solid Core
32" x 40" 4-ply
 17% 50+ sheets 7% 25-49 sheets List 1-24 sheets

Item #	Color	Item #	Color	Item #	Color
B8740	Solid White	B8747	Solid Grey	B8756	Solid Ecru
B8741	Solid Black	B8748	Solid Prato	B8757	Solid Ebony
B8742	Solid Wheat	B8749	Solid Chrome	B8758	Solid Ivory
B8743	Solid Sand	B8750	Solid Loam	B8759	Solid Slate
B8744	Solid Malacca	B8751	Solid Ash	B8760	Solid Pearl
B8745	Solid Pampas	B8752	Solid Fango		

Artcare AlphaEssentials 100%
Alpha Cellulose Solid Core
40" x 60" 4-ply
 17% 50+ sheets 7% 25-49 sheets List 1-24 sheets

Item #	Color	Item #	Color
BL8740	Solid White	BL8741	Solid Black

Artcare AlphaEssentials 100%
Alpha Cellulose Solid Core
32" x 40" Double Thick
 17% 50+ sheets 7% 25-49 sheets List 1-24 sheets

Item #	Color	Item #	Color
B8740.8	Solid White	BTM8744	Malacca
B8741.8	Solid Black	BTM8749	Chrome
B8742.8	Wheat	BTM8751	Ash
B8747.8	Grey		

Artcare AlphaEssentials 100%
Alpha Cellulose Solid Core
40" x 60" 8-ply
 17% 50+ sheets 7% 25-49 sheets List 1-24 sheets

Item #	Color	Item #	Color
BL8740.8	Solid White	BL8741.8	Solid Black

Artcare Rustic Essentials Specialties
 Subtle surface texture, 100% archival
32" x 40" 4-ply
 17% 50+ sheets 7% 25-49 sheets List 1-24 sheets

Item #	Color	Item #	Color
B998741	Old Bronze	B998747	Weathered Zinc
B998743	Vintage Oak	B998751	Ironwork
		B998752	Dark Clay

Black Core
32" x 40" 4-ply
 17% 50+ sheets 7% 25-49 sheets List 1-24 sheets

Item #	Color	Item #	Color
B5089	Black/Black Core	B5770	Soapstone/Black Core
B5754	Porcelain/Black Core		

Black Core
40" x 60" 4-ply
 17% 50+ sheets 7% 25-49 sheets List 1-24 sheets

Item #	Color	Item #	Color
BL5089	Black/Black Core	BL5754	Porcelain/Black Core

Bainbridge®

Conservation Basics 32" x 40" Double Thick Topmat (6-ply)

17% 7% List
50+ Sheets 25-49 Sheets 1-24 Sheets

Item #	Color	Item #	Color	Item #	Color
BTM12016	Bridal Veil	BTM12021	Anthracite	BTM12025	True Blue

Conservation Basics 32" x 40" 4-ply 25/pack

20% 17% 7% List
Full Pack 50+ Sheets 25-49 Sheets 1-24 Sheets

Item #	Color	Item #	Color	Item #	Color
B12001	Nougat	B12024	Bungalow	B12067	Jaded
B12003	Brown	B12025	True Blue	B12069	Mallard
B12004	Kid Glove	B12026	Navy	B12080	Chili Sauce
B12005	Cotton	B12027	True Red	B12081	Sunshine
B12006	Primer White	B12029	Peppercorn	B12082	Butter
B12007	Meringue	B12030	Blue Moon	B12083	Light Grey
B12008	Whipped Cream	B12034	Butterscotch	B12084	Black Olive
B12009	Camel	B12042	Oxblood	B12085	Marshmallow
B12010	Cork	B12045	Shamrock	B12086	Castlerock
B12012	Storm Cloud	B12048	Jungle	B12087	Brightest White
B12014	Portabella	B12052	Bristol	B12088	Egret
B12015	Truffle	B12058	Mosaic Blue	B12089	Flame
B12016	Bridal Veil	B12059	Apricot	B12090	Myrtle
B12017	Corinthian White	B12060	Tomato	B12091	Chartreuse
B12019	Leaf	B12062	Kelly	B12093	Dragonfly
B12020	Iron	B12063	Dusk	B12094	Ultra Violet
B12021	Anthracite	B12064	Silver Blue	B12096	Purple Heart
B12022	Daisy	B12065	Iceberg		
B12023	Snowdrop	B12066	Crocodile		

Conservation Black Core 32" x 40" 4-ply

17% 7% List
50+ Sheets 25-49 Sheets 1-24 Sheets

Item #	Color	Item #	Color	Item #	Color
B13006	Primer White	B13016	Bridal Veil	B13025	True Blue
B13012	Storm Cloud	B13021	Anthracite Black	B13027	True Red

Conservation Basics 40" x 60" 4-ply 25/pack

17% 7% List
50+ Sheets 25-49 Sheets 1-24 Sheets

Item #	Color	Item #	Color	Item #	Color
BL12001	Nougat	BL12012	Storm Cloud	BL12025	True Blue
BL12003	Brown	BL12016	Bridal Veil	BL12026	Navy
BL12004	Kid Glove	BL12017	Corinthian White	BL12027	True Red
BL12005	Cotton	BL12018	Scone	BL12028	Red Pepper
BL12006	Primer White	BL12020	Iron	BL12029	Peppercorn
BL12008	Whipped Cream	BL12021	Anthracite	BL12030	Blue Moon
BL12009	Camel	BL12022	Daisy		
BL12010	Cork	BL12023	Snowdrop		

Conservation Basics New Threads 32" x 40"

17% 7% List
50+ Sheets 25-49 Sheets 1-24 Sheets

Item #	Color	Item #	Color	Item #	Color
B4099	Nightshade	B4115	Forest Floor	B4132	Bamboo
B4101	Navy	B4116	Courtyard	B4135	Café au Lait
B4104	White	B4126	Majestic Brown		
B4111	Scarlet	B4127	Brick Oven		

Conservation Basics New Threads 40" x 60"

17% 7% List
50+ Sheets 25-49 Sheets 1-24 Sheets

Item #	Color	Item #	Color	Item #	Color
BL4099	Nightshade	BL4104	White	BL4127	Brick Oven
BL4101	Navy	BL4126	Majestic Brown	BL4135	Café au Lait

Conservation Basics Suedes 32" x 40"

17% 7% List
50+ Sheets 25-49 Sheets 1-24 Sheets

Item #	Color	Item #	Color	Item #	Color
B4150	Midnight	B4176	White	B4223	Blaze
B4151	Sonoma	B4197	Shadow	B4236	Blueberry
B4165	Coal	B4221	Sundrenched		

Conservation Basics Suedes 40" x 60"

17% 7% List
50+ Sheets 25-49 Sheets 1-24 Sheets

Item #	Color	Item #	Color
BL4150	Midnight	BL4223	Blaze
BL4165	Coal	BL4236	Blueberry

Basics Solids 32" x 40"

17% 7% List
50+ Sheets 25-49 Sheets 1-24 Sheets

Item #	Color	Item #	Color	Item #	Color
B8710	Snow	B8713	Sand	B8715	Light Grey
B8712	Cream	B8714	Buff		

Basics Solids 32" x 40"

17% 7% List
50+ Sheets 25-49 Sheets 1-24 Sheets

Item #	Color
B8711	Jet

Basics Solids 40" x 60"

17% 7% List
50+ Sheets 25-49 Sheets 1-24 Sheets

Item #	Color	Item #	Color
BL8710	Snow	BL8711	Jet

Museum Basics 32" x 40"

17% 7% List
50+ Sheets 25-49 Sheets 1-24 Sheets

Item #	Color	Item #	Color	Item #	Color
B8605	White	B8612	Off White	B8613	Bright White
B8610	Alabaster				

Museum Basics 32" x 40"

17% 7% List
50+ Sheets 25-49 Sheets 1-24 Sheets

Item #	Color	Item #	Color
B8611	Coal	B8615	Soft Black

Museum Basics 40" x 60"

17% 7% List
50+ Sheets 25-49 Sheets 1-24 Sheets

Item #	Color
BL8605	White

Museum Basics
40" x 60"
 17% 7% List
 50+ sheets 25-49 sheets 1-24 sheets

Item #	Color
BL8611	Coal

Fabrics & Textures

Bainbridge offers the most extensive range of Fabrics and Textures, so you and your customers remain at the cutting edge of design. All are on an Alphamat archival core and backing for timeless style and long-lasting beauty.

Fabric Mat - AlphaLinens
32" x 40"
 17% 7% List
 50+ sheets 25-49 sheets 1-24 sheets

Item #	Color	Item #	Color	Item #	Color
B4020	Raphael Cloud	B4023	Rembrandt Shadow	B4027	Gauguin Green
B4021	Monet Lily	B4024	Vermeer Black		
B4022	Seurat Sand	B4025	Titian Gold		

Fabric Mat - AstroTurf
32" x 40"
 17% 7% List
 50+ sheets 25-49 sheets 1-24 sheets

Item #	Color
B4310	Astro Turf

Fabric Mat - Crushed Chiffons
32" x 40"
 17% 7% List
 50+ sheets 25-49 sheets 1-24 sheets

Item #	Color
B4032	Obsidian

Fabric Mat - Distressed Old World Metals
32" x 40"
 17% 7% List
 50+ sheets 25-49 sheets 1-24 sheets

Item #	Color	Item #	Color	Item #	Color
B4312	Gilded Cream	B4315	Travertine	B4316	Grey Slate

Fabric Mat - Driftwoods
32" x 40"
 17% 7% List
 50+ sheets 25-49 sheets 1-24 sheets

Item #	Color
B4333	Ashbark

Fabric Mat - Glazed Linen
32" x 40"
 17% 7% List
 50+ sheets 25-49 sheets 1-24 sheets

Item #	Color	Item #	Color	Item #	Color
B4075	Peatmoss	B4080	Charred Black	B4290	Graphite
B4078	Brick Wall	B4281	Oasis		
B4079	Oatmeal	B4289	Dusty Ash		

Fabric Mat - Grass Cloth
32" x 40"
 17% 7% List
 50+ sheets 25-49 sheets 1-24 s heets

Item #	Color
B4406	Whiteweave

Fabric Mat - Metallic Rice Papers & Slates
32" x 40"
 17% 7% List
 50+ sheets 25-49 sheets 1-24 sheets

Item #	Color	Item #	Color	Item #	Color
B4013	Candlelight Silver	B4702	Gold Coin	B4706	Gentian
B4352	Verdigris	B4704	Bridal Path	B4707	Niagara
B4355	Verona	B4705	Crystal	B4709	Moonlight
B4700	White Armor			B4710	Pumice

Fabric Mat - New Threads
32" x 40"
 17% 7% List
 50+ sheets 25-49 sheets 1-24 sheets

Item #	Color	Item #	Color	Item #	Color
B4091	Meringue	B4113	Autumn Frost	B4119	Grappa
B4097	Camel	B4114	Enchanted Purple	B4121	Orange Zest
B4112	Watchet Blue	B4117	Greician White	B4125	Ancient Stone

Fabric Mat - New Threads
40" x 60" 4-ply
 17% 7% List
 50+ sheets 25-49 sheets 1-24 sheets

Item #	Color	Item #	Color
BL4097	Camel	BL4113	Autumn Frost

Fabric Mat - Old World Metals
32" x 40" 4-ply
 17% 7% List
 50+ sheets 25-49 sheets 1-24 sheets

Item #	Color	Item #	Color
B4300	Cinnabar	B4303	Aragon
B4301	Faberge Gold	B4366	Spun Gold
B4302	Silver Leaf		

Fabric Mat - Raw Silk
32" x 40" 4-ply
 17% 7% List
 50+ sheets 25-49 sheets 1-24 sheets

Item #	Color	Item #	Color	Item #	Color
B4960	Oyster	B4964	Greenbrier	B4970	Black Knight

Fabric Mat - Rice Papers
32" x 40" 4-ply
 17% 7% List
 50+ sheets 25-49 sheets 1-24 sheets

Item #	Color
B4008	Gold Dust

Fabric Mat - Shantung
32" x 40" 4-ply
 17% 7% List
 50+ sheets 25-49 sheets 1-24 sheets

Item #	Color	Item #	Color	Item #	Color
B4853	Dolphin	B4856	Cottage Blue	B4859	Coconut
B4854	Caffe	B4857	Passionfruit		
B4855	New Moon	B4858	Pimento		

Bainbridge®

Fabric Mat - Silken

32" x 40" 4-ply

17% 7% List
50+ sheets 25-49 sheets 1-24 sheets

Item #	Color	Item #	Color	Item #	Color
B4830	Snow	B4838	Dynasty Red	B4846	Molten
B4834	Petal Green	B4840	White	B4847	Meadowland
B4835	Mountain Green	B4843	Wheatfield	B4848	Shitake
B4836	Imperial Blue	B4844	Burnt Ember	B4850	Wasabi
B4837	Burgundy			B4851	Tabriz

Fabric Mat - Silken

40" x 60" 4-ply

17% 7% List
50+ sheets 25-49 sheets 1-24 sheets

Item #	Color	Item #	Color	Item #	Color
BL4836	Imperial Blue	BL4838	Dynasty Red	BL4844	Burnt Ember
BL4837	Burgundy			BL4846	Molten

Fabric Mat - Suedes

32" x 40" 4-ply

17% 7% List
50+ sheets 25-49 sheets 1-24 sheets

Item #	Color	Item #	Color	Item #	Color
B4146	Willow	B4162	Rosewood	B4210	Prato Suede
B4147	Spruce	B4169	Lapis	B4216	Vivid Purple
B4148	Moss	B4179	Noel	B4228	Raspberry Fizz
B4153	Jacana	B4180	Cabernet	B4232	Vivid Turquoise
B4154	Targa	B4183	Persimmon		
B4157	Grey	B4199	Verde Suede		

Fabric Mat - Suedes

40" x 60" 4-ply

17% 7% List
50+ sheets 25-49 sheets 1-24 sheets

Item #	Color	Item #	Color	Item #	Color
BL4180	Cabernet	BL4183	Persimmon	BL4216	Vivid Purple

Fabric Mat - Tailored Textiles

32" x 40"

17% 7% List
50+ sheets 25-49 sheets 1-24 sheets
\$48.58/sh

Item #	Color	Item #	Color	Item #	Color
B4420	Burlap	B4427	Chino	B4428	Heather Grey

Fabric Mat - Tatami Silks

32" x 40" 4-ply

17% 7% List
50+ sheets 25-49 sheets 1-24 sheets

Item #	Color	Item #	Color	Item #	Color
B4410	Golden Samurai	B4423	Candlestick	B4440	Dill
B4411	Chai	B4424	Jasper	B4451	Pistachio
B4412	Sake	B4426	Caramel	B4452	Peach Melba
B4413	Salt Grass	B4429	Delft	B4454	Violetta
B4415	Bonsai Brown	B4430	Jundo	B4457	Phantom
B4416	Lily Pond	B4432	Umi	B4459	Nightshade
B4417	Hibachi	B4433	Katana	B4460	Tourmaline
B4418	Harmony Blue	B4434	Kazan	B4461	Chincilla
B4419	Kyoto Pearl	B4435	Sumi		
B4421	Fawn	B4436	Torri		

Formal Mats

32" x 40" 4-ply

17% 7% List
50+ sheets 25-49 sheets 1-24 sheets

Item #	Color	Item #	Color
B7501	Platinum	B9506	Graphite/Black Core
B7506	Graphite		

PaperMat:

Made of exceptional quality. Excellent for matting art work, photographs and even prints.

PaperMat

32" x 40" 4-ply 25/pack

20% 17% 7% List
Full Pack 50+ sheets 25-49 sheets 1-24 sheets

Item #	Color	Item #	Color	Item #	Color
B41	Charcoal	B587	China Blue	B815	Ruby
B61	Super White	B594	Maple Leaf	B817	Liberty Blue
B65	Fabric White	B742	Cerulean	B819	Alpine Blue
B71	Brilliant White	B744	Sienna	B824	Chantilly
B84	Dark Green	B751	Ebony	B836	Royal
B88	T.V. Grey	B754	Porcelain	B865	Laurel
B89	Black	B762	Rouge	B866	Burnt Orange
B128	Off White	B770	Soapstone	B868	Forest Green
B203	Cream	B772	Bisque	B879	Sand
B213	Gold	B776	Peat	B885	Delft Blue
B414	Sea Foam	B795	Slate		
B586	Blue Jay				

PaperMat

40" x 60" 4-ply

17% 7% List
50+ sheets 25-49 sheets 1-24 sheets

Item #	Color	Item #	Color	Item #	Color
BL71	Brilliant White	BL754	Porcelain	BL89	Black

CUSTOM MAT BOARD CUTTING

For ALL MATBOARDS

(Bainbridge, Crescent, Essence, Value Line and Rising)

and BACKING MATERIALS

(foamboard, corrugated sheets and mounting boards)

Item #	Description	List
OPTIONS		
CMC	Custom Mat Cutting	Minimum Charge
<i>Then you need to order either #CMO or #CMB</i>		
CMO	Cut Mat Opening	<i>you supply us with the glass size and the mat opening size.</i>
OVS	Hand Cut Mat Opening > 40x60	<i>for mats larger than 40x60</i>
CMB	Cut Mat Backs	<i>you supply us with the frame size.</i>
Please supply a detailed drawing of the mat and how you want us to cut it. Supply any special border information.		

DECOR METAL MOULDINGS

Available as Length and Chop

Metal Profile #2

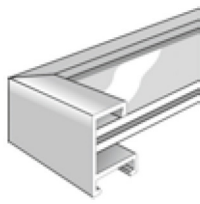
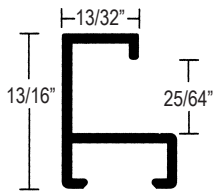

Style #	Finish
2-CG	Contrast Grey
2-FG	Frosted Gold
2-FS	Frosted Silver
2-MBL	Matte Black
2-S	Silver
2-SBL	Shiny Black

Metal Profile #5

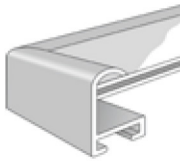
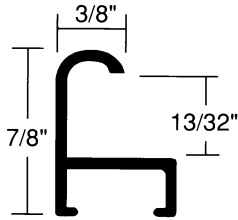

Style #	Finish
5-G	Gold
5-GS	German Silver
5-MBL	Matte Black
5-S	Silver
5-SBL	Shiny Black

Metal Profile #11

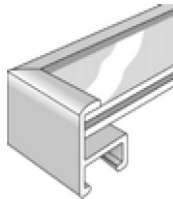
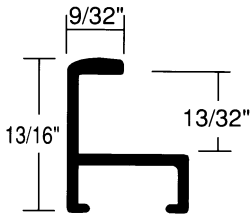

Style #	Finish
11-CG	Contrast Grey
11-FG	Frosted Gold
11-FS	Frosted Silver
11-G	Gold
11-GS	German Silver
11-MBL	Matte Black
11-P	Pewter
11-S	Silver
11-SBL	Shiny Black

Metal Profile #15

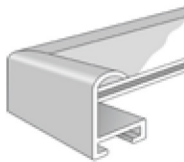
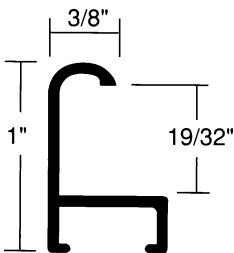

Style #	Finish
15-CG	Contrast Grey
15-FG	Frosted Gold
15-FS	Frosted Silver
15-G	Gold
15-GS	German Silver
15-MBL	Matte Black
15-S	Silver
15-SBL	Shiny Black

Metal Profile #31

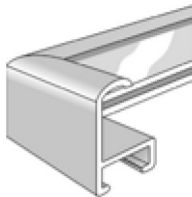
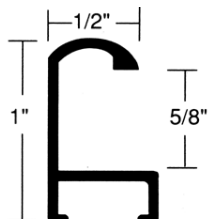

Style #	Finish
31-G	Gold
31-S	Silver
31-SBL	Shiny Black

DECOR METAL MOULDINGS

Style No.	Width inches	Rabbet Height inches	-10% 100' Mixed	Length Cost Per Ft.	Chop Cost Per Ft.	Join Cost Per Ft.	Box Price	Appx. Box Qty.	Mldg. Pg. No.
2CG	1.0	3/8	1.73	-	-	-	1.15	400	193
2FG	1.0	3/8	1.58	-	-	-	1.05	400	193
2FS	1.0	3/8	1.58	-	-	-	1.05	400	193
2MBL	1.0	3/8	1.58	-	-	-	1.05	400	193
2S	1.0	3/8	1.73	-	-	-	1.15	400	193
2SBL	1.0	3/8	1.73	-	-	-	1.15	400	193
5G	1.0	13/32	1.49	-	-	-	0.99	400	193
5GS	1.0	13/32	1.49	-	-	-	0.99	400	193
5MBL	1.0	13/32	1.49	-	-	-	0.99	400	193
5S	1.0	13/32	1.62	-	-	-	1.08	400	193
5SBL	1.0	13/32	1.49	-	-	-	0.99	400	193
11CG	1.0	13/32	1.62	-	-	-	1.08	400	193
11FG	1.0	13/32	1.49	-	-	-	0.99	400	193
11FS	1.0	13/32	1.49	-	-	-	0.99	400	193
11G	1.0	13/32	1.62	-	-	-	1.08	400	193
11GS	1.0	13/32	1.49	-	-	-	0.99	400	193
11MBL	1.0	13/32	1.49	-	-	-	0.99	400	193
11P	1.0	13/32	1.49	-	-	-	0.99	400	193
11S	1.0	13/32	1.62	-	-	-	1.08	400	193
11SBL	1.0	13/32	1.62	-	-	-	1.08	400	193
15CG	1.0	19/32	1.80	-	-	-	1.20	320	193
15FG	1.0	19/32	1.80	-	-	-	1.20	320	193
15FS	1.0	19/32	1.67	-	-	-	1.11	320	193
15G	1.0	19/32	1.80	-	-	-	1.20	320	193
15GS	1.0	19/32	1.80	-	-	-	1.20	320	193
15MBL	1.0	19/32	1.80	-	-	-	1.20	320	193
15S	1.0	19/32	1.71	-	-	-	1.14	320	193
15SBL	1.0	19/32	1.80	-	-	-	1.20	320	193
31G	1.0	5/8	1.76	-	-	-	1.17	320	193
31S	1.0	5/8	1.76	-	-	-	1.17	320	193
31SBL	1.0	5/8	1.76	-	-	-	1.17	320	193

METAL FRAME HARDWARE



Item	Quantity	Price	Item	Quantity	Price
Screw-in Hanger					
399 <input checked="" type="checkbox"/>	100/box		399T	1000/box	
Zinc Plated Tapped Corner Angle w/Set Screws inserted					
400 <input checked="" type="checkbox"/>	100/box		400T	1000/box	
Back Plate Angle to be used w/#400 (#400T)					
401 <input checked="" type="checkbox"/>	100/box		401T	1000/box	
3/8" Spring Clip-center notched					
402 <input checked="" type="checkbox"/>	100/box		402T	1000/box	
European Hanger w/Set Screw					
403 <input checked="" type="checkbox"/>	100/box		403T	1000/box	
Snap in Hanger after Frame is Assembled					
404 <input checked="" type="checkbox"/>	100/box		404T	1000/box	

Enough Hardware for 1 Frame

Item #1-SCREW		Item #1-SNAP	
Includes:		Includes:	
Item #	Qty	Item #	Qty
#400	4 Pcs.	#400	4 Pcs.
#401	4 Pcs.	#401	4 Pcs.
#402	8 Pcs.	#402	8 Pcs.
#403	2 Pcs.	#404	2 Pcs.
Bumpers	4 Pcs.	Bumpers	4 Pcs.
Item #	1 @	Item #	10 + @
1-SCREW <input checked="" type="checkbox"/>		1-SNAP <input checked="" type="checkbox"/>	

























Enough Hardware for 100 Frames

Item #100-SCREW		Item #100-SNAP	
Includes:		Includes:	
Item #	Qty	Item #	Qty
#400	400 Pcs.	#400	400 Pcs.
#401	400 Pcs.	#401	400 Pcs.
#402	800 Pcs.	#402	800 Pcs.
#403	200 Pcs.	#404	200 Pcs.
Bumpers	400 Pcs.	Bumpers	400 Pcs.
Item #	1 @	Item #	2 + @ 5 + @
100-SCREW		100-SNAP	

SAVE 10%

SAVE 5% SAVE 10%

Length Moulding & Chop Service Price List
25% OFF ALL CHOPS!

ANODIZED AND COLORWAVE MOULDING												
STD PACK FT / LBS			PRICE CODE									
PROFILE	ANODIZED	PAINTED SPECIALTY	SILVER, GOLD PAINTED (A1 & C)		BLACK, OTHER (A2)		SPECIALTY I (S1)		SPECIALTY II (S2)		SPECIALTY III (S3)	
			ML	CH	ML	CH	ML	CH	ML	CH	ML	CH
11		400' / 53#	200' / 28#									
12		160' / 24#	160' / 24#									
13		90' / 17#	-									
14		80' / 30#	-									
15		320' / 48#	160' / 25#									
21		120' / 22#	120' / 22#									
22		120' / 24#	-									
24		-	120' / 19#									
25		120' / 19#	-									
33		-	160' / 24#									
34		240' / 41#	230' / 41#									
35		100' / 31#	-									
58		400' / 56#	-									
65		-	120' / 25#									
71		240' / 49#	-									
93		160' / 27#	160' / 27#									
94		120' / 25#	120' / 25#									
95		90' / 24#	90' / 24#									
97		100' / 17#	100' / 17#									
99		120' / 25#	120' / 25#									
100		70' / 32#	-									
117		120' / 46#	120' / 46#									
129		120' / 29#	120' / 29#									
130		-	120' / 31#									
225		-	90' / 25#									

CHOPS

FREE UPS
 for ORDERS OVER \$100
 CAN BE COMBINED WITH WOOD
 CHOPS

**NIELSEN CHOP
 DISCOUNTS**

25% OFF ALL CHOPS
30% OFF 3 or MORE/order

Minimum footage/frame is 4 feet.
 Footage is calculated by rounding off to the
 next higher half foot.

LENGTH
**LARGEST NIELSEN
 DISCOUNTS**

(All 10 foot sticks)

300 Feet Mixed - 10%
500 Feet Mixed - 15%
1000 Feet Mixed - 25%

Color Key:

• **SILVER/GOLD/ PAINTED (A1&C):**
 Silver, Frosted Silver, Gold, Pale Gold,
 Frosted Gold, Antique Gold, Painted/
 Colorwave

• **BLACK/OTHER (A2):**
 Matte Black, Anodic Black, All other
 Anodized

• **SPECIALTY I (S1):**
 Florentine, Metalline, Tuscan Linen,
 Satin Lustre, Metalware, Brushed

• **SPECIALTY II (S2):**
 Brushed Satin, Duotone, Embossed,
 Embossed Specialty, Forged

**CALL FOR
 SPECIAL QUOTES
 ON LARGER QUANTITIES**

Availability Chart by Profile

PROFILE 11

Ref#	Color Name
01	Silver
02	Frosted Silver
03	Gold
04	Frosted Gold
08	Frosted Bronze
10	Graphite
12	Frosted Pewter
13	Contrast Grey
14	German Silver
20	Anodic Black
21	Matte Black
23	Antique Gold
50	Black
154	Florentine Grey
156	Florentine Black

PROFILE 12

Ref#	Color Name
02	Frosted Silver
21	Matte Black

PROFILE 13

Ref#	Color Name
14	German Silver
21	Matte Black

PROFILE 14

Ref#	Color Name
14	German Silver
21	Matte Black

PROFILE 15

Ref#	Color Name
01	Silver
02	Frosted Silver
03	Gold
04	Frosted Gold
08	Frosted Bronze
10	Graphite
12	Frosted Pewter
13	Contrast Grey
14	German Silver
19	Frosted Walnut
20	Anodic Black
21	Matte Black
23	Antique Gold
24	Cobalt
50	Black
52	Bright White
55	Right Red
58	Indigo
66	Lapis
68	Chinese Red
150	Florentine Silver
153	Florentine Pewter
154	Florentine Grey
155	Florentine Amber
156	Florentine Black
164	Dusk
170	Frosted Umber

PROFILE 21

Ref#	Color Name
07	Shiny Rose Gold
08	Frosted Rose Gold
21	Matte Black
23	Antique Gold
50	Matte Black
227	Tornado Red
233	Purple Haze
235	Tangerine Twist
243	Pearlized Brown
248	China Blue
250	Merlot
257	Sapphire
258	Really Teal
261	Dawn
400	Chrome

PROFILE 22

Ref#	Color Name
01	Silver
02	Frosted Silver
03	Gold
14	German Silver
20	Anodic Black
21	Matte Black

PROFILE 24

Ref#	Color Name
414	Brushed Satin German Silver
421	Brushed Satin Black
423	Brushed Satin Antique Gold
469	Brushed Satin Stainless Steel
471	Brushed Satin Slate
475	Brushed Satin Chocolate
476	Brushed Satin Sapphire

PROFILE 25

Ref#	Color Name
01	Silver
02	Frosted Silver
04	Frosted Gold
14	German Silver
20	Anodic Black
21	Matte Black

PROFILE 33

Ref#	Color Name
50	Black

PROFILE 34

Ref#	Color Name
14	German Silver
21	Matte Black
179	Black Metalline
280	American Natural

PROFILE 35

Ref#	Color Name
01	Silver
20	Anodic Black

PROFILE 58

Ref#	Color Name
01	Silver
02	Frosted Silver
03	Gold
04	Frosted Gold
14	German Silver
19	Frosted Walnut
20	Anodic Black
21	Matte Black

PROFILE 65

Ref#	Color Name
245	Spice
246	Old Gold
247	Gunmetal
251	Barely Gold
252	Robin's Egg
280	American Natural
282	Walnut
421	Brushed Satin Black
429	Brushed Anodic Black

PROFILE 71

Ref#	Color Name
01	Silver
21	Matte Black

PROFILE 93

Ref#	Color Name
01	Silver
04	Frosted Gold
14	German Silver
19	Frosted Walnut
20	Anodic Black
21	Matte Black
23	Antique Gold
50	Black
52	Bright White
150	Florentine Silver
154	Florentine Grey
156	Florentine Black
170	Frosted Umber
550	Tuscan Linen Silver
552	Tuscan Linen Raw Steel
553	Tuscan Linen Caramel
555	Tuscan Linen Amber
556	Tuscan Linen Black
557	Tuscan Linen Pewter
558	Tuscan Linen Slate

PROFILE 94

Ref#	Color Name
02	Frosted Silver
21	Matte Black
156	Florentine Black

PROFILE 95

Ref#	Color Name
10	Graphite
14	German Silver
21	Matte Black
23	Antique Gold
224	Matte White
429	Brushed Anodic Black
470	Brushed Satin Nickel

PROFILE 97

Ref#	Color Name
14	German Silver
21	Matte Black
50	Black
150	Florentine Silver
151	Florentine Gold
154	Florentine Grey
155	Florentine Amber
156	Florentine Black
167	Florentine Walnut
400	Brushed Aluminum Satin
550	Tuscan Linen Silver
552	Tuscan Linen Raw Steel
553	Tuscan Linen Caramel
555	Tuscan Linen Amber
556	Tuscan Linen Black
557	Tuscan Linen Pewter
558	Tuscan Linen Slate

PROFILE 99

Ref#	Color Name
21	Matte Black
150	Florentine Silver
154	Florentine Grey
156	Florentine Black
167	Florentine Walnut
421	Brushed Black Satin
430	Brushed German Silver
470	Brushed Satin Nickel
475	Brushed Satin Chocolate
478	Brushed Satin Pewter

PROFILE 100

Ref#	Color Name
14	German Silver
21	Matte Black

PROFILE 117

Ref#	Color Name
01	Silver
02	Frosted Silver
04	Frosted Gold
10	Graphite
12	Frosted Pewter
14	German Silver
19	Frosted Walnut
20	Anodic Black
21	Matte Black
23	Antique Gold
50	Black
52	Bright White
69	Black Bean
164	Dusk
227	Tornado Red
230	Reflex Silver
231	Gold Bullion
232	Galactic Blue
233	Purple Haze
235	Tangerine Twist
236	Cyber Green
237	Raspberry Fizz
238	Turquoise
240	Amethyst
270	Burnt Sienna
280	American Natural
400	Brushed Aluminum Satin
470	Brushed Satin Nickel
478	Brushed Satin Pewter

PROFILE 129

Ref#	Color Name
01	Silver
07	Bronze
13	Contrast Gray
15	Amber
20	Anodic Black
21	Matte Black
52	Bright White

PROFILE 130

Ref#	Color Name
52	Bright White
400	Brushed Satin Aluminum
414	Brushed Satin German Silver
421	Brushed Satin Black
423	Brushed Satin Antique Gold
475	Brushed Satin Chocolate

PROFILE 225

Ref#	Color Name
154	Graphite
319	Cappuccino
421	Jet Black
452	Frosted Gold
469	Modern Pewter

Profile Dimensions

PROFILE 11

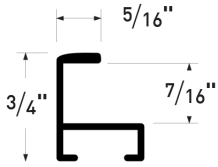

PROFILE 22

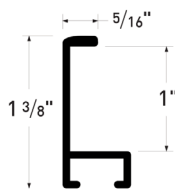

PROFILE 35

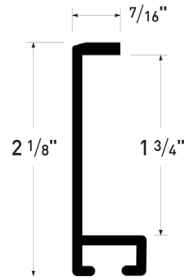

PROFILE 94

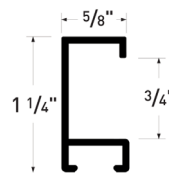

PROFILE 117

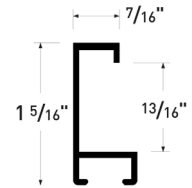

PROFILE 12

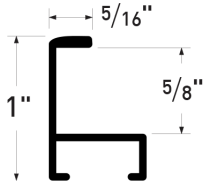

PROFILE 24

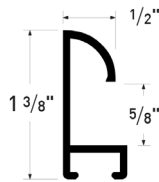

PROFILE 58

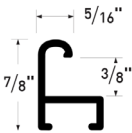

PROFILE 95

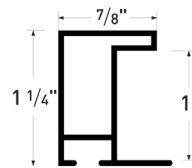

PROFILE 129

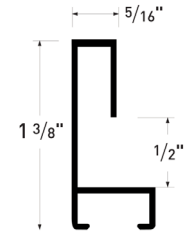

PROFILE 13

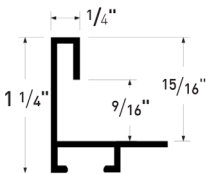

PROFILE 25

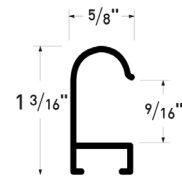

PROFILE 65

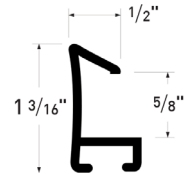

PROFILE 97

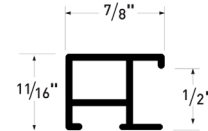

PROFILE 130

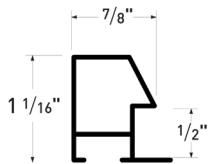

PROFILE 14

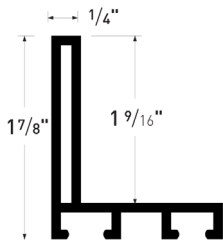

PROFILE 33

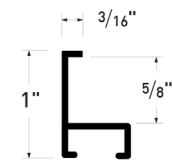

PROFILE 71

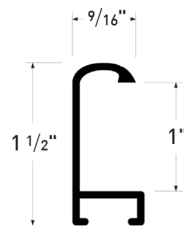

PROFILE 99

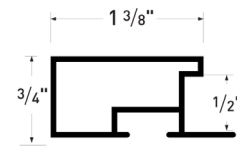

PROFILE 225

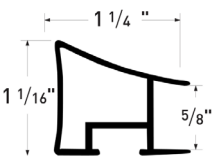

PROFILE 15

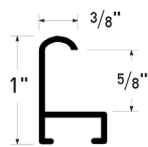

PROFILE 34

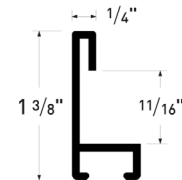

PROFILE 93

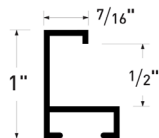

PROFILE 100

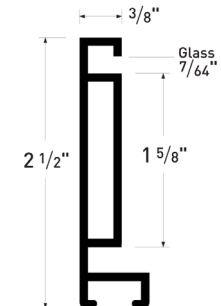

PROFILE 21

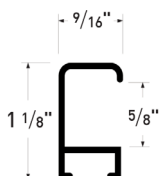

For actual sizes, see the Nielsen Moulding Catalog. Nielsen® is a registered trademark of NielsenBainbridge, LLC

INDEX

- A -

Abaca.sa Paper Hinging Tape.....15
 Acid-Free ATG Tapes.....8-9
 Acid-Free Backing Paper.....17
 Acid-Free Buffered Tissue by Lineco.....15
 Acid-Free Framers Tape.....14
 Acid-Free Gummed Linen Tape.....15
 Acid-Free Foamboard.....4-5
 Acid-Free Masking Tape.....12
 Acid-Free Pressure Sens Linen Tape.....15
 Acid-Free Self-Adhesive Photo Corners.....14
 Archival Spacers.....18-19
ACRYLIC by Acrylite & TruVue.....3
 Acrylic Cutters.....6
 Adaptor Kits for ATG Dispensers.....10
 Adhesives
 Fabric.....5, 33
 Glues.....33
 Methyl Cellulose.....17
 Neutral pH.....17
 PMA.....11
 Pure Rice Starch.....17
 Pure Wheat Starch.....17
 Sprays.....5, 32
 Adhesive Hangers, Pressure Sensitive.....19
 Adhesive Release Solvent, Unstik.....32
 Adhesive Remover, un-du®.....32
 Adjustable Picture Hangers, Hook-Ups.....22
 Air, Canned.....7
 Aluminum Frame Hardware.....25, 71
AMP Machinery.....45
AMP V-Nails.....44
 Anchors.....28-29
 Anti-Reflection Glass.....3
 Anti-Static Brushes.....34
 Anti-Static Gloves.....34
 Anti-Static Panther Cloth.....34
 Anti-Static Tiger Cloth.....34
 Apron, Denim Shop.....35
 AR Reflection-Free Glass by TruVue.....13
 Art Conservation Products.....4-17
 Archival Heat Reversible Dry Mount Tissue.....41
 Archival Clear Mounting Corners.....14
 Archival Full-View Corners by Lineco.....14
 Archival Spacers.....18-19
 ArtCare Restore Foamboard.....4
 Artist Tape, White Writable.....13
 ATG Dispensers/Guns.....10
 ATG EZ Glide Adaptor.....10
 ATG Tapes:
 Acid-Free ATG Tapes.....8-9
 Decor Acid-Free ATG Tape.....8
 Handheld ATG Tapes.....8-9
 Super ATG Tape.....8
 3M 908 Gold Acid-Free.....9
 3M 924 ATG.....8
 3M Hand Held ATG #465.....9
 3M Hi-Tac ATG #969.....9
 3M Highland ATG #987.....8
 3M VHB Tape.....9

- B -

Backer Paper, Gray by Lineco.....17
 Bags, Plastic.....20
 Bags, Resealable.....20
 Bainbridge Foamboard.....4
Bainbridge Matboards.....64-70
 Ball Glass Cutters.....6
 Balsa Wood Spacers.....19
 Barrier Paper, Museum.....53, 61
 Bars, Hanging Clear.....28
 Beveled Mirrors.....5
 Bienfang.....40, 52
 Black Bison Fine Paste Wax.....37
 Black Anti-Static Panther Cloth.....34
 Black-Crepe Masking Tape.....12
 Black Flat Back Tape.....12
 Black Kraft Paper.....21
 Black Patinating Wax.....37
 Black Surface w/Black Core Foam.....4-5
 Blades:
 alto type.....47
 carbide tipped.....46
 chopper.....46
 combination.....46
 C+H brand.....51
 Decor Kleen-Cut.....47, 51
 Dexter type.....47
 Footchopper.....46
 hobby.....47
 Kleen-Cut™.....47, 51
 Logan.....51
 no notch (Razor Kleen-Cut).....47
 mat (cutter).....47-51
 metal.....46
 notched (Razor Kleen-Cut).....47
 plastic.....46
 razor.....47
 saw.....46
 sharpening services.....46
 utility.....47
 wood.....46
 Board & Glass Cutters.....48-50
 Bones, Burnishing.....34
 Box Sealing Tape/Dispenser.....13
 Brad Gun Nailer, F18.....44
 Brad Nails, Steel Wire.....46
 Brads 3/4".....44
 Braided Picture Wire.....27
 Brass Capped Steel Nails.....22

- B continued -

Brass Knurled Cap Nails.....22
 Brass Plated Goodwill Hangers.....22
 Broad Tip Marker.....37
 Brush, Anti-Static.....34
 Brush, Dusting.....34
 Brush 'N Leaf.....35
 Buffered Acid-Free Tissue by Lineco.....15
 Buffermount Acid-Free Rev Dry Mt.....40
 Bubble Wrap.....20
 Bumpers, Rubber, Felt, Foam, Cork.....39
 Burnishing Bones.....34

- C -

C+H Brand Blades.....51
 Canned Air.....7
 Canvas Films.....40
 Canvas Spring Clips.....24
 Canvas Stretching Pliers.....52
 Carbide Tipped Saw Blades.....46
 Carbide Wheel Glass Cutter.....6
 Cardboard Corners.....39
 Cassese Cartridges.....44
 Center Finding Ruler.....51
 Centerfold Shrink Film.....21
 Channels for Easel Backs.....38
 Chartpak Touch Up Kit.....35
 Chevron Velcro Fasteners.....51
 Chopper Blades.....46
 Chopper, Fletcher Fillet.....48
 Circle & Oval Mat Cutters.....48, 50
 Cleaning Pad.....34
 Clear FF3 Acrylic.....3
 Clear Mounting Adhesive.....41
 Clear Mounting Corners, Archival.....14
 Clear Hanging Bars.....28
 Clear Hanging Bar Security Hardware.....28
 Clips, Offset with screws.....24
 Clips, Canvas Spring.....24
 Cloths, Lintless Wiping.....34
 Coated Picture Wire.....26-27
 Cold Vacuum Presses.....52
 Color Markers.....36-37
 Conservation OP3 Acrylic.....3
 Conservation Clear Glass by TruVue.....3
 Conservation Mount Corners.....14
 Conservation Products.....14-17
 Conservation Reflection Contri Glass by TruVue.....3
 Cork Bumpers.....39
 Corner Angles.....30
 Corner Fasteners, Velcro.....51
 Corner Nails.....44
 Corner Protectors.....39
 Corners, Full-View Archival by Lineco.....14
 Coroplast Acid-Free Plastic Sheets.....17, 63
 Corrugated Sheets.....39
 Cotton Gloves.....34
 Courtesy Hangers.....22
 Crayons, Retouch.....36
 Cream, Gilt.....36
Crescent Matboards.....55-63
 Crimper, Wire.....26
 Crystal Clear Glass.....2
 Crystal Clear Tape.....13
 Custom Cuttable Mirrors.....5
 Cutters: Glass, Plastic & Board.....6, 48-50
 Cutters, Kraft Paper.....21
 Cutters, Paper.....21, 47
 Cutting Acrylic.....3
 Cutting Matboards, Custom Cut.....70

- D -

D & K.....40, 52
 Daubers, woodstain.....35
 Deacidification Spray.....17
 Decor ATG Tapes.....8
 Decor Metal Mouldings.....71
 Decor Value Line Matboards.....54
 Denim Shop Apron.....35
 Dexter Blades.....47
 Dexter Mat Cutter.....50
 Diamantor Glass Cutter.....6
 Diamond Points #2 by Fletcher.....42
 Dirtex Glass Cleaners.....7
 Disc Sander.....45
 Dispensers:
 ATG.....10
 box sealing/packing tape.....13
 EZ Glide Adaptor.....10
 mainline (Scotch).....13
 tabletop.....13
 Door Back Easel Backs.....38
 Double Coated Film Tape.....12
 Double-Ended Art Markers.....36
 Double Face Vinyl Tape.....12
 Double Mitre Saws.....45
 Double Wing Self-Stick Easel Backs.....38
 Dry Mount Film & Tissues.....40-41
 Dual Point Hand-held Driver by Decor.....43
 Dual Point Pneumatic Driver by Decor.....43
 Dual Elite Point Driver by Logan.....43
 DuPont "Melinex 516" Mylar "D".....20
 Dura-Lon Coated Picture Wire.....27
 Dust-Off.....7
 Dusting Brush.....34
 Dry Cleaning Pad.....34
 Dry Mount Press, Mechanical.....52
 Dry Mounting Tissue.....40-41
 Dry Tac products.....40-41

- E -

Easel Backs.....38
 Easel Backs: Self Stick.....38

- E continued -

Easel Back Plastic Channels.....38
 EaselMates by Fletcher.....38
 Econospace by FrameTek.....18
 Eraser, Kneaded.....37
Essence Matboards.....53
 EZ Glide ATG Adaptor.....10

- F -

F18 Brad Gun Nailer.....44
 Fabric Adhesive.....5, 33
 Fabric Fastening Tag Guns, Kit.....31
 Fasteners for Fine Fabric & Micro Stitch Guns.....31
 Fast Tack #87 by Sprayway.....5
 Felt Bumpers.....39
 Filament Tape.....13
 Filler, Nail Hole.....35-37
 Fillet Chopper by Fletcher.....48
 Fillet Hand-Held Wizard Cutter.....18
 Film, Shrink.....21
 Filmoplast Tapes.....16
 Films, Overlaminating.....40
 Fine Fabric Tag Guns, Needles, Fasteners.....31
 Fine Paste Wax.....37
 Fine Point Markers.....37
 Finish Guard UV Films.....30
 Fixative Spray by Sprayway.....42
 Flanger Hangers.....22
 Flat Back Tapes.....12
 Flat Turnbuttons.....38
 Fletcher 2200 Cutting System.....48
 Fletcher 3000/3100 Multi-Material Cutters.....49
 Fletcher F-60 Cutter.....48
 Fletcher Compatible Flexi Points.....43
 Fletcher FrameMaster Points.....42
 Fletcher FSC Substrate Cutter.....49
 Fletcher Glass Cutters.....6, 48-49
 Fletcher Nipping Pliers.....2
 Fletcher Plastic Cutters.....6
 Fletcher Points.....42
Fletcher Products.....6, 38, 42, 48-49
 Fleximaster Point Driver by Fletcher.....42
 Flexi Point Drivers / Guns.....42-43
 Flexi Points.....42-44
 Flip Stops, Pistorius.....46
 Fluid Dispensing Glass Cutter by Fletcher.....6
 Flobond Adhesive by Dry Tac.....41
 Fluted Polypropylene Sheets.....17, 63
 Foam/Fabric Adhesive.....5, 33
 Foam for Vacuum Press.....41
 Foam Pads.....39
Foamboard.....4-5, 63
 Foamboard Single Sheets.....63
 Foamboard Cutters.....48-49
 Foil Rabbit & Frame Sealing Tape.....16
 Footchopper Blades (Knives).....46
 Frame Mounting Bracket.....28
 Frame Backer Paper by Lineco, acid-free.....17
 Framemaster Point Driver by Fletcher.....42
 FrameMate 2-in-1 by Fletcher.....42
 Framers' Points for Fletcher.....42-43
 Framers' Stitchery Tape.....14
 Framers' Tape II.....14
 Framers Tape, Acid-Free.....14
 Frames, Packages.....31
 Framespace by FrameTek.....18
 FrameTek Spacers.....18
 Framing Vises, 4" and 7".....46
 FSC Substrate Cutter by Fletcher.....49
 Fusion 4000 Dry Mount Film.....40

- G -

Gaffers Tape.....11
 Gatorfoam® board.....4, 17, 63
 GE Silicone Glue & Seal.....33
 Gilman Foamboard.....4
 Gilt Cream/Filler Sticks.....36
 Glass.....2-3
 Glass Cleaners.....7
 Glass Cutters, Hand-held.....6
 Glass Cutter by Fletcher.....6, 48-49
 Glass Pliers.....2
 Glaziers Points.....42-43
 Gloss, Preserve It Spray by Krylon.....17, 32
 Gloves, Anti-Static.....34
 Gloves, Cotton.....34
 Glues:
 framers glue.....33
 GE Silicone Glue.....33
 hot melt.....33
 mounting.....33
 Neutral pH adhesive.....17
 polystyrene.....33
 wood.....33
 Gold 908 Acid-Free ATG Tape.....9
 Gold Leaf, Sepp.....37
 Gold Metallic Markers.....37
 Goggles, Safety.....51
 Goodwill Hangers & Pins.....22
 Graphic Art Sprays.....32
 Gray Backer Paper, acid-free.....17
 Gummed Linen, Acid-Free Tape.....15
 Gummed Linen Hinging Tapes.....15
 Gummed Paper Hinging Tape.....15

- H -

Hand Held ATG Tapes.....8-9
 Hand Mat Cutters.....50
 Hand Miter Cutter.....18
 Hang Rite Foam Pads.....39

- H continued -

Hangers:
 Cleat Hanging Bars.....28
 Courtesy / Goodwill.....22
 Flangers.....22
 Hook-Ups.....23
 Keyhole.....22
 Metal frames.....25, 29
 Mirror.....23
 Picture.....22-24
 Picture poster.....4
 Pressure sensitive adhesive.....19
 S-moulding hooks.....23
 Sawtooth.....24
 Security.....25, 28-29
 Super Steel.....23
 Wallbuddies.....24
 Hanging Cleat Bars.....28
 Hansen Footchopper Knives.....46
 Hard Point Drivers.....43
 Hardware for Metal Frames.....25, 71
 Hassle Free Trimming Knife.....47
 Hayaku Gummed Hinging Tape.....15
 Heads, Replacement V-Nail.....45
 Heat Gun, Dual Temperature.....21
 Heat Activated Foamboard.....4
 Heat Reversible Acid-Free Dry Mt Film.....40
 Heat Seal Film.....26
 Heat Shrinkable Wire Wraps.....26
 Hi-Tac ATG Tapes.....8-9
 Highland #987 ATG Tapes by 3M.....8
 Highland Tape Dispenser.....13
 Hinging Tapes by Lineco.....15
 Hobby Knives & Blades.....47
 Hook & Loop, Velcro.....51
 Hook-Ups Adjustable Hangers.....22
 Hot Melt Glue & Applicator.....33
 Hot Press Vacuum Presses.....52

- I -

i-Film by Lineco.....16
 Industrial U-Glu Tape.....9
 Inserts, thumb nail.....32
 Inside Corner Angle.....30
 Invisible Clear Tape.....13
 Invisible Mending Tape.....52
 Irons, Tacking.....11
 ITW/AMP Brand V-Nails.....44
ITW/AMP Machinery.....45

- J -

J-Lar Crystal Clear Tape.....13
 Joiner, Logan F300-2.....50

- K -

Keyhole Hanger.....23
 Kleen-Cut Blades.....47, 51
 Klucel G Cellulose Adhesive.....15
 Kneaded Eraser.....37
Kool Tack Foamboard.....5
 Knife:
 hobby.....47
 trimming.....47
 utility.....47
 X-acto type.....47
 Zippy Cutting Tool.....47
 Knives (Blades), footchopper.....46
 Knurled Cap Nails.....22
 Kraft Paper Cutters.....21, 47
 Kraft Paper: natural and black.....21
 Kraft Paper Tape, Pressure Sensitive.....13
 Krylon Paints & Sprays.....32
 Krylon Gloss Preserve It.....32

- L -

Laminating Films.....40
 Leather, Faux Easel Backs.....38
 Liberon Products.....36-37
 Lineco Acid-Free Photo Corners.....14
 Lineco Abaca.sa Paper Hinging Tape.....15
 Lineco Adhesives.....17
 Lineco Backer Paper.....17
 Lineco Easel Backs.....38
 Lineco Full-View Archival Corners.....14
 Lineco Gummed Linen Tapes.....15
 Lineco Hinging Mounting Tissue/Paper.....15
 Lineco Mounting Strips, See-Thru.....14
 Lineco Museum Mounting Kit.....15
 Lineco Mylar Mounting Corners.....14
 Lineco pH Testing Pen.....17
 Lineco See-Thru Mounting Strips.....14
Lineco Tapes & Tissues.....14-17
 Linen Cloth Tape by Lineco.....15
 Linen Films.....40
 Lint and Dust Remover.....7
 Lintless Wiping Cloth.....34
 Logan Blades.....51
 Logan Compact Mat Cutter.....50
 Logan Elite Point Driver.....43
 Logan F100-5 Saw Fence Kit.....50
 Logan F300-2 Pro Joiner.....50
 Logan Hand Held Matter Cutters.....50
 Logan Mat Cutters.....50
 Logan Oval & Circle Matter Cutter.....50
 Logan Platinum Edge Mat Cutters.....50
 Logan Points.....43
 Logan Simplex Plus Mat Cutters.....50
 Long Nose Pneumatic Stapler.....44
 Long Screw Eyes.....23
 Loop Fabric for Velcro hook.....51

- M -

Magic Transparent Tapes.....11
 Mainline Tape Dispenser by Scotch.....13
 Markers for Touch-Up.....35-37
 Masking Tapes:
 acid-free.....12
 black-crepe.....12
 black flat back.....12
 Decor Economical.....12
 Decor Premium.....12
 flat back.....12
 white flat back.....12
 3M Highland.....12
 3M Scotch #234.....12
 Mat Blades.....47-49, 51
 Mat Cutters.....48-50
 Mat Savers.....34
 Matboards:
 Bainbridge.....64-70
 Crescent.....55-63
 Decor Value Line.....54
 Essence.....53
 Rising.....53
 Matboard Custom Cutting.....70
 Matboard Cutters.....48-50
 Matboard Seconds.....54
 Matte Films.....40
 MDF V-Nails.....44
 Mechanical Dry Mount Press.....52
 Melinex 516 Mylar "D" Film.....20
 Mending Tapes by 3M.....11
 Metal Moulding, Decor Brand.....71
 Metal, Nielsen Brand.....72-74
 Metal Hardware.....25, 29, 71
 Metal Saw Blades.....46
 Metal Security Hangers.....25, 29
 Metallic Markers.....37
 Metall Cellulose Adhesive.....17
 Micro-Stitch Tag Gun.....31
 Mini Frames.....31
 Mini Hand Mat Cutters.....50
 Miracle Core Picture Wire.....26
 Mirror Hangers.....22-24
 Mirrors.....5
 Miter Hand Cutter.....18
 Miter Saw, Pneumatic.....45
 Miter Vises 4" and 7".....46
 Morso Footcopper Knives.....46
 Mounting Adhesive.....5, 33
 Mounting Boards.....61, 63
 Mounting Corners, Archival.....14
 Mounting Glue.....33
 Mounting Strips, See-Thru by Lineco.....14
 Mounting Tissues/Films.....15, 40-41
 Mulberry Hinging Paper by Lineco.....15
 Multi-Material Cutters by Fletcher.....49
 MultiMaster Driver & Points by Fletcher.....42
 Museum Barrier Paper.....53, 61
 Museum Glass by TruVue.....3
 Museum Mounting Kit.....15
 Mylar "D" film.....20
 Mylar Mounting Corners.....14

- N -

Nail Hole Fillers.....35-37
 Nail-less Sawtooth Hangers.....24
 Nails, Brad Steel Wire.....46
 Nails, Brass Capped Steel.....22
 Nails, Brass Knurled Cap.....22
 Nails Corner.....44
 Nails V-Type.....44
 Needles for Tag Guns.....31
 Nickel Plated Goodwill Hangers.....22
 Nielsen Brand Metal Hardware.....25
 Nielsen Brand Metals.....72-74
 Nielsen Router Bit.....32
 Nipping Pliers by Fletcher.....3
 Non-Glare P99 Acrylic.....3
 Non-Glare Glass.....2
 Novus Plastic Cleaner.....7
 Novus Scratch Remover.....7

- O -

Offset Clips with screws.....24
 Optium AR Acrylic.....3
 Optium Museum Acrylic.....3
 Oval & Circle Mat Cutters.....48, 50
 Overlaminating Films.....40

- P -

Packing Tape & Dispensers.....13
 Paints, Spray by Krylon.....32
 Pan Head Screws.....30
 Panther Anti-Static Black Cloth.....34
 Paper, Gray Frame Backer by Lineco.....17
 Paper Cutters.....21, 47
 Paper Hinging Tape.....15
 Paper, Kraft.....21
 Patinating Wax.....37
 Perma Join Wood Glue.....33
 pH Neutral Transparent Mending Tape.....15
 pH Testing Pen.....17
 Phenolic Chip Breaker Support.....46
 Phenolic Fence Insert.....46
 Phillips Head Screws.....30
 Photo Corners, Self-Adhesive.....14
 Photo-Mount Spray Adhesive by 3M.....5
 Picture Hangers.....4, 22-25
 Picture Frame Touch Ups.....35-37
 Picture Poster Prong Hanger.....4
 Picture Wire.....26-27
 Pilot Broad Tip Marker.....37
 Pilot Metallic Markers.....37

- P continued -

Pins/Nails.....22
 Pistorius Footcopper Knives.....46
 Pistorius Production Flip Stop.....46
 Pistorius V-Nails.....44
 Plastic Bags on Rolls.....20
 Plastic Bags, Resealable Clear.....20
 Plastic Channels for Easel Backs.....38
 Plastic Cleaners.....7
 Plastic Coated Picture Wire, Dura-Lon™.....27
 Plastic Cutters.....6
 Plastic Scratch Remover.....7
 Plastic Spray Clear Fixative.....32
 Platinum Edge Mat Cutters by Logan.....50
 Pliers, Canvas & Glass.....3, 52
 PMA (Positionable Mounting Adhesive).....11
 Pneumatic Drivers.....42-43
 Pneumatic Stapler.....44
 Point Driver by Logan.....43
Point Drivers by Fletcher.....42
 Points for Fletcher.....42-43
 Points, Glaziers.....42-43
 Points, 5/8" Universal.....44
PolyBond™ Glue.....33
 Poly Foam on Rolls.....20
 Polypropylene Fluted Sheets.....17, 63
 Polystyrene Glue.....33
 Polystyrene Saw Blade.....46
 Positional Mounting Adhesive (PMA).....11
 Premium Clear Glass by TruVue.....2
 Premium Masking Tapes.....12
 Premium ATG Tapes.....8
 Preserve It, Gloss Spray.....17, 32
 Presses, Mechanical Dry Mount.....52
 Pressure Sensitive Adhesive Hangers.....19
 Pressure Sensitive Foamboard.....4, 63
 Pressure Sensitive Kraft Paper Tape.....13
 Print Holders.....20
 Prismacolor Markers.....36
 Prong Hanger.....4
 Production Stop, Pistorius.....46
 PullMate by Fletcher.....42
 PushMate by Fletcher.....42
 Push Pins.....32
 Putty.....35-37

- Q -
 Quick Clip Attachment System.....26

- R -

Rabbit Sealing Tapes.....16
 Rabbetspace by FrameTek.....18
 Rag Mount Acid-Free Dry Mt Tissue.....40
 Razor Blades.....47-49, 51
 Red Devil Ball Glass Cutter.....6
 Red Devil Plastic Cutter.....6
Reflection Control Glass by TruVue.....2
 Release Boards.....40
 Release Paper.....40
 Release Solvent, UnStik.....32
 Removable Tapes #811 by 3M.....21
 Replacement V-Nail Heads.....45
 Repositionable Mounting Adhesive.....5, 11
 Resealable Clear Bags.....20
 Resharpening Saw Blades.....46
 Retouch Crayons.....36
 Reversible Trim Knife.....47
 Rice Starch Adhesive.....17
 Ridge Turnbuttons.....38
Rising Matboard.....53
 Rollers, Rubber.....34
 Rottenstone.....37
 Router Bit.....32
 Rub 'N Buff.....35
 Rubber Bumpers.....39
 Rubber Rollers.....34
 Rulers.....51
 Running/Nipping Pliers.....3
 Ryno Board (see Gator Foamboard).....63

- S -

S-Moulding Hooks.....23
 Safety Goggles.....51
 Sander, Disc.....45
 Sanding Disc, 12" round.....45-46
 Satin Finish Laminating Film.....40
 Saw, Pneumatic Double Mitre.....45
 Saw Blades.....46
 Saw Blades Resharpening.....46
 Saw Cleaner Spray.....46
 Sawtooth Hangers.....32
 Scoremaster II Glass Cutter.....6
 Scorematic Double Edge Plastic Cutter.....6
 Scotch Hot Melt Glue Applicator.....33
 Scotch Mainline Tape Dispenser.....13
 Scraper, Retractable Type.....47
 Scratch Remover for Plastics.....7
 Screw Eyes.....23
 Screws.....29-30
 Sealing Tape.....13
 Security Hangers/Hardware.....25, 28-29
 Security Slotted Bracket.....29
 Security T-Screws.....29
 Self-Adhesive Acid-Free Photo Corners.....14
 Self-Adhesive (Pressure Sensitive) Foamboard.....4, 63
 Self-Stick Easel Backs.....38
 Sepp Gold Leaf.....37
 Sharpening Saw Blades.....46
 Sharpie Fine Point Markers.....37
 Shop Apron, Denim.....35
 Short Screw Eyes.....23
 Shrink Films.....21
 Shrink Sealer/Wrap Machines.....21

- S continued -

Shrinkable Wire Wraps.....26
 Silicone Release Paper.....41
 Silicone Glue by GE.....33
 Silver Metallic Markers.....37
 Single Sheet Foamboard.....63
 Single Wing Self-Stick Easel Backs.....38
 Slide-In Mounting Bracket.....29
 Softstrand Picture Wire.....27
 Spacers, Archival.....18-19
 SpeedMount Foamboard.....4
 Sponge Overlay Foam, Vacuum Press.....40
 Spray Can Handle.....32
 Spray Paints by Krylon.....32
 Spraymount Adhesive by 3M.....5
 Sprays:
 acrylic cleaner.....7
 adhesive.....5, 32
 deacidification.....17
 fixative by Sprayway.....32
 foam & fabric adhesive by 3M.....5
 glass cleaner.....7
 gloss preserve it.....17, 32
 Krylon.....32
 matte.....32
 paints.....32
 photo mount.....5
 plastic cleaners.....7
 satin varnish.....32
 Saw Cleaner.....46
 Spraymount Repositionable by 3M.....5
 Super 77 by 3M.....5
 Vac-U-Mount by 3M.....5
 varnish.....32

Sprayway:
 Fast Tack #87.....5
 Glass Cleaner.....7
 Lint/Dust Remover.....7
 Plastic Cleaner.....7
 Plastic Spray Clear Fixative.....32
 Saw Cleaner.....46
 SpringMate by Fletcher.....42
 Spring Clips.....24-25
 Stainless Steel Picture Wire.....26-27
 Stapler, Long Nose Pneumatic.....44
 Staples.....44
 Steel Hangers.....23
 Steel Plates.....30
 Steel Straight Edge.....51
 Steel Wire Brad Nails.....46
 Stitchery Tape.....14
 Stops, Production for Pistorius.....46
 Straight Edged Rulers.....51
 Strapping (Filament) Tape.....13
 Stretch Wraps.....20
 Substrate Cutter FSC by Fletcher.....49
 Suede Value Line Matboards.....54
 Super 77 Spray by 3M.....5
 Super Softstrand Picture Wire.....27
 Super Steel Hangers.....23
 Surfion Nylon Coated Picture Wire.....26
 Swiss Clips.....31

- T -

T-Screws.....29
 Tabletop Tape Dispensers.....13
 Tacking Irons.....52
 Tag Guns.....31
 Tape Dispensers:
 Adaptor Kits for ATG dispensers.....

10 ATG.....10
 box.....13
 mainline (Scotch).....13
 table top.....13
 Tape Measure.....51

Tapes:
 Acid-Free ATG Tapes.....8-9
 Acid-Free Framers Tape.....14
 Acid-Free Masking Tape.....12
 Acid-Free Pressure Sens Linen.....15
 Artist, White Writable.....13
 ATG.....8-9
 black-crepe masking tape.....12
 black flat back tape.....12
 box sealing.....13
 clear invisible.....13
 crepe masking tape.....12
 double coated film tape.....12
 double face vinyl.....12
 filament.....13
 Filmoplast.....16
 flat back.....12
 frame sealing tapes.....16
 Framers's Stitchery.....14
 Framers's Tape II.....14
 Gaffers.....11
 gummed linen, acid-free.....15
 gummed linen hinging tapes.....15
 hand-held ATG tapes.....8-9
 Highland ATG Tapes.....13
 Highland masking.....12
 Highland mending.....11
 Highland transparent.....11
 hinging tapes.....15
 invisible clear.....13
 i-Film tape by Lineco.....16
 J-Lar Crystal Clear tape.....13
 kraft, pressure sensitive.....13
 Linen Cloth Tape.....15
 Magic Transparent #810 by 3M.....11
 masking.....12

- T continued -

Tapes: continued
 mending invisible by 3M.....11
 packing.....13
 pressure sensitive kraft.....13
 Rabbit Sealing Tapes.....16
 Removable #811 by 3M.....11
 Stitchery Tape.....14
Strapping (filament).....13
 Transparent #600 by 3M.....11
 Tyvek Tapes by Lineco.....16
 U-Glu Industrial Tapes.....9
 VHB Tape.....9
 Volara Rabbit Sealing tape by Lineco.....16
 white artist tape.....13
 white flat back.....12
 white paper.....13

- U -

U-Glu Tapes.....9
Ultra-Vue Anti-Reflection Glass.....3
 un-du Adhesive Remover.....32
 Underpinners.....45
 Unstik Adhesive Release Solvent.....32
 Utility Blades and Knives.....47

- V -

Vacuum Mounting Adhesive.....33
 Vacuum Presses, Hot/Cold.....52
 Vacuum Press Overlay Foam.....40
 Value Line Decor Matboards.....54
 VHB Tape.....9
V-Nail Machines.....45
 V-Nail Replacement Heads.....45
 V-Nails.....44
 Velcoins.....51
 Velcro, Hook & Loop.....51
 Velcro Corner Fasteners.....51
 Velcro Triangle Fasteners.....51
 Velour Easel Backs.....38
 Vinyl, Double Face Tape.....12
 Vistamount Dry Mount Tissue.....41
 Volara Rabbit Sealing Tape.....16
 Vises 4" and 7", Miter.....46

- W -

Wall Cutting Systems by Fletcher.....49
 Wall Mounting Bracket.....28
 Wallbuddies.....24
 Wax.....37
 Wax Filler Sticks.....36
 Wheat Starch Adhesive.....17
 Wheeled Glass Cutter.....6
 White Core Value Line Matboards.....54
 White Flat Back Tape.....12
 White Paper Tape.....13
 White Writable Artist Tape.....13
 Wiping Cloth, Lintless.....34

Wire:
 Decor Braided.....27
 Decor Stainless Steel.....27
 Dura-Lon.....27
 Softstrand.....27
 Super Softstrand.....27
 Surfion Nylon Coated.....26
 Wire Crimper.....26
 Wire Cutter.....26
 Wire Wraps, Shrinkable.....26
 Wizard Miter Hand Cutter.....18
 Wood Frame Hardware.....30
 Wood Glue.....33
 Wood Nail Hole Fillers.....35-37
 Wood Security Hardware.....28-29
 Woodstain Daubers.....35
 Wrap, Bubble.....20
 Wrap, Stretch.....20
 Wraps, Shrinkable for Picture Wire.....26
 Wrench for Security Hangers.....29
 Writable White Artist Tape.....13

- X -
 X-Acto Type Knife.....47

- Z -

Z-Bars, Cleat Hanging.....28
 Zer-Lon (see Dura-Lon Coated Picture Wire)
 Zippy Paper Cutter.....47

INDEX by Item Number

Item #	Pg.	Item #	Pg.	Item #	Pg.	Item #	Pg.	Item #	Pg.	Item #	Pg.	Item #	Pg.	Item #	Pg.
01729	14	138	4	350	12	434T	30	535	35	645	47	753	23	858	38
01730	14	140	5	351	12	435	30	536	35	646	34	754	23	859	38
01731	14	141	5	352	12	435T	30	540	35	647	35	755	23	860	38
01732	14	143	5	353	12	436	30	541	35	648	34	756	23	861	38
01733	14	144	5	355	13	436T	30	542	35	650	43	757	23	862	38
04072	45	150	4	356	12	437	30	543	51	651	34	758	23	863	38
04073	45	152	4	357	12	437T	30	544	51	652	6	759	23	864	38
1-SCREW	25	153	4	358	12	442	30	546	24	653	6	760	30	865	38
1-SNAP	25	154	4	359	12	442T	30	546T	24	654	51	761	14	866	38
10-CBO	46	155	4	360	13	443	30	547	29	655	34	762	14	867	20
10-CTM	46	156	4	361	13	443T	30	547H	29	656	34	765	28	868	43
10-CTW	46	157	4	362	13	444	30	547T	29	658	5	767	38	869	43
12-CBO	46	158	4	364	8	444T	30	548	24	660	50	768	51	870	28
12-CTM	46	159	4	365	8	445	30	548T	24	665	50	769	33	871	28
12-CTW	46	160	4	366	8	445T	30	549	24	666	50	770	33	872	22
12-CTW-1	46	161	4	367	8	446	30	549T	24	667	50	771	19	872T	22
12-P	46	165	4	368	8	446T	30	550	24	668	50	772	19	873	22
14-CTW	14	168	4	369	8	447	30	550T	24	669	50	773	19	873T	22
18-40	21	169	4	370	8	447T	30	551	24	670	50	774	19	874	22
20-1	35	200	63	371	8	450	32	551T	24	671	50	775	19	874T	22
20-2	35	201	63	372	43	451	32	552	8	672	41	776	44	875	22
20-3	35	202	63	373	43	452	32	553	8	673	41	777	44	875T	22
21-1	35	203	63	374	13	453	32	554	8	674	41	778	44	876	22
21-2	35	204	63	375	13	454	32	555	8	675	41	779	44	876T	22
21-3	35	205	63	376	13	455	32	556	8	681	40	780	44	877	22
21-4	35	206	63	377	14	457	32	557	9	682	40	781	44	878	22
21-5	35	208	63	378	14	458	32	558	9	689	40	782	44	879	22
21-6	35	210	63	379	14	459	32	559	9	691	40	783	44	880	22
21-15	35	211	63	380	13	461	32	560	9	695	44	784	43	881	22
21-20	35	212	63	381	44	462	32	561	9	696	7	785	43	882	22
21-22	35	213	63	382	16	465	32	562	9	697	7	786	43	883	22
22-3	35	214	63	383	16	471	32	563	9	698	7	787	41	887	21
22-5	35	215	63	384	16	474	32	564	9	700	9	788	41	888	21
22-7	35	217	63	385	16	475	32	568	12	701	9	789	41	889	21
23-1	35	218	63	386	16	476	32	569	12	702	9	790	41	890	21
23-2	35	219	63	387	44	477	32	570	12	703	9	791	41	891	21
23-4	35	220	63	388	44	478	32	571	12	704	9	793	41	892	21
23-7	35	221	63	389	44	479	51	572	12	705	23	794	41	893	21
23-8	35	230	63	391	15	480	47	573	12	705T	23	795	41	894	21
23-9	35	231	63	392	20	481	47	575	13	706	23	796	41	895	21
24-40	21	233	63	393	13	482	47	576	13	706T	23	797	41	896	6
24-50R	21	235	63	394	13	483	51	578	11	707	23	798	41	897	6
30-40	21	238	63	400	25	484	51	580	11	707T	23	799	19	898	47
36-40	21	240	63	400T	25	485	51	582	11	708	23	800	41	899	32
36-50	21	241	63	401	25	486	47	583	11	708T	23	802	41	900	32
36-50R	21	242	63	401T	25	487	47	584	11	709	23	803	41	901	30
40-50	21	243	63	402	25	488	47	585	10	709T	23	804	41	902	30
48-50	21	244	63	402T	25	489	47	586	10	712	38	807	40	904	28
58C	3	265	4, 17, 63	403	25	490	51	587	10	713	38	808	40	905	28
59C	3	266	4, 17, 63	403T	25	491	51	588	8	714	23	812	41	907	39
60C	3	267	4, 17, 63	404	25	492	47	589	8	714T	23	813	41	908	39
61C	3	268	4, 17, 63	404T	25	493	47	590	13	715	23	815	24	912	39
62C	3	269	4, 17, 63	405	24	494	47	591	13	715T	23	816	24	916	24
64C	3	270	40	405T	24	495	47	592	13	716	23	817	27	916T	24
67C	3	271	40	406	24	496	47	593	13	716T	23	818	27	917	24
76-1	35	274	63	406T	24	497	47	595	5	717	11	819	27	917T	24
76-2	35	275	63	407	24	498	47	596	5	718	11	820	27	918	38
76-3	35	278	17	407T	24	499	47	597	5	719	11	821	27	921	12
76-4	35	279	17	408	24	500	50	598	9	721	12	822	27	922	12
76-5	35	280	17, 63	408T	24	502	47	599	9	722	12	823	24	923	12
76-6	35	281	17, 63	409	24	503	47	600	32	725	22	823T	24	924	12
76-8	35	289	46	409T	24	504	29	601	32	725B	22	824	24	925	12
76-12	35	296	7	410	24	505	29	602	32	726	22	824T	24	926	23
76-13	35	297	51	410T	24	506	29	603	32	726B	22	825	24	926H	23
100	4	298	51	411	24	507	29	604	39	727	22	825T	24	926T	23
100-SCREW	25	300	51	411T	24	508	29	605	39	727B	22	826	20	933	38
100-SNAP	25	301	51	412	24	509	29	606	39	728	22	827	6	934	52
101	4	302	51	412T	24	509H	29	607	39	728B	22	829	27	935	52
102	4	303	51	413	24	509T	29	608	39	729	22	830	27	937	45, 46
102P	4	304	51	413T	24	510	29	609	39	729B	22	831	27	938	50
103	4	305	51	419	30	510H	29	610	33	730	23	832	27	939	19
103P	4	308	51	419T	30	510T	29	612	44	731	23	833	27	940	19
104	4	310	7	420	30	511	29	613	44	732	23	834	27	941	19
105	4	311	33	420T	30	511H	29	614	44	733	23	835	27	942	19
106	4	313	8	421	30	511T	29	615	44	734	23	836	7	943	19
107	4	314	8	421T	30	512	51	616	44	735	23	837	7	944	19
108	4	315	8	422	30	513	51	617	44	736	23	838	23	945	7
109	4	317	8	422T	30	514	51	618	44	737	23	838T	23	946	7
110	4	318	8	423	30	515	51	619	44	738	23	839	23	947	24
111	4	319	8	423T	30	516	29	620	44	740-2	27	839T	23	948	24
112	4	320	10	424	30	516H	29	621	44	740-3	27	840	30	949	24
113	4	321	21	424T	30	516T	29	622	44	740-4	27	841	30	950	24
114	4	322	21	425	30	518	35	623	44	740-5	27	842	30	951	24
115	4	323	21	425T	30	519	35	624	44	740-6	27	843	30	952	24
116	4	331	8	426	30	520	35	625	44	740-8	27	845	39	953	15
117	4	332	8	426T	30	521	35	626	44	741	23	846	39	954	50
118	4	336	13	427	30	522	35	627	44	742	23	847	5	955	40
119	4	337	13	427T	30	523	35	633	32	743	23	848	38	956	40
120	4	338	13	428	30	524	35	635	46	744	23	849	38	957	40
121	4	340	12	428T	30	525	35	636	46	745	23	850	38	958	40
125	4	341	12	431	30	526	35	637	43	746	23	851	38	959	40
126	4	342	12	431T	30	527	35	638	43	747	23	852	38	963	40
127	4	343	12	432	30	528	35	639	33	748	23	853	38	964	40
130	4	344	12	432T	30	529	35	640	44	749	23	854	38	965	40
131	4	346	12	433	30	530	35	642	44	750	23	855	38	966	40
133	4	347	12	433T	30	531	35	643	43	751	23	856	38	967	40
135	4</														

DECOR ... The Industry's Source for Moulding, Hardware and Supplies



**Contact us for pricing on the best quality
Picture Frame Moulding, Hardware and Supplies**

- Order from our extensive moulding and framing supplies catalogs filled with the brands and products you know and use.
- Supplier to Retailers, Contractors and Distributors.
- Multiple distribution centers to fulfill your orders and ship quickly.
- Choose the company that has one of the largest inventory stocks in the industry.
- Partner with a company that the industry recognizes and trusts.
- When you call, we answer. All customers receive personalized customer service.

Visit www.decormoulding.com to access our complete family of Moulding, Framing Hardware and Supplies catalogs



FRAMING SUPPLIES

ORDERING INFORMATION:

When placing your order, please provide the following information:

- Your Decor/Southern Account Number .
 - Item Number and Quantity.
 - Preferred Method of Shipment and Destination.
 - To Insure Accuracy, We Will Read Your Phone Orders Back To You.
- Our automated attendant is available to take your orders after regular office hours and on weekends.

TERMS: Net 10 days from receipt of merchandise.

CREDIT: To open your account, please complete our application with three trade references and the name of your bank. Allow approximately 2 weeks processing to establish an approved credit line. Should credit be established, all decisions with respect to the extension or continuation shall be in the sole discretion of Decor. Decor may terminate any credit availability within its sole discretion. Until credit is approved a check must accompany the order or, with your approval, we will ship C.O.D.

CREDIT CARDS:

We accept Visa, MasterCard, Discover and American Express.

REMITTANCE:

Please write your Decor/Southern account number and invoice numbers on your check and return with the remittance copy of your invoice.

MISCELLANEOUS:

- UPS C.O.D. charge will be added to all UPS C.O.D. shipments.
- A 4.95 handling charge will be added to all invoices under 65.00.
- Orders will not be shipped to past due accounts.
- A finance charge of 1½ percent per month will be charged to all invoices past due.
- There is a \$30.00 charge to your account each time a NSF check is processed.
- In the event of default of payment, the customer shall pay for all costs of collection, including, but not limited to, attorney's fees and collection agency fees.
- *All prices are subject to change without notice.*

GENERAL MATBOARD COMMENTS:

- Minimum quantity for UPS shipment is 15, 32 x 40 sheets per box.

- 40 x 60 mat board, foamboard and corrugated sheets must be shipped by our truck delivery service or by common carrier.
- 40 x 60 mat board, foamboard and corrugated sheets can not be combined with 32 x 40 for quantity price discounts.
- Foamboard and corrugated sheets may be used to reach quantity discounts and for minimum UPS shipment levels.
- Full pack quantities do not count toward other discount levels.

SHIPMENTS:

- F.O.B. Hauppauge, NY or F.O.B. Kennesaw, GA unless otherwise stated. Shipments will be made by manner requested. If specific instructions are not given we will use our discretion.
- UPS - maximum size - 130 inches (length plus girth) and 150 pounds per package.
- Additional charges for packages over 48 inches or its 2nd longest side exceeding 30 inches, for C.O.D. shipments and packages over 50 pounds.
- UPS Ground shipments are automatically charged at the greater of the actual weight or the Domestic dimensional weight. The Domestic dimensional weight calculation is length x width x height divided by DIM divisor.

LOCAL DELIVERY:

- If your delivery falls on a holiday, your order will be delivered on your next scheduled delivery day.
- All local deliveries totaling less than \$100.00 will incur a \$10.95 delivery charge.
- All local deliveries incur the current fuel surcharge.

DAMAGES:

We are not liable for loss or damage by carrier. In the event of damage, save the merchandise and original packaging so that a proper claim can be filed. You must note external carton damage or box shortage on the carrier bill of lading or U.P.S. receipt before signing. Truck (common carrier) claims must be filed directly with the carrier. U.P.S. claims must be filed by Decor/Southern.

RETURNS:

- Return of any merchandise will not be accepted without prior authorization from Decor/Southern. All questions regarding your order should be addressed to us in writing within 10 days of receipt of order.
- No returns will be authorized after 30 days from receipt of goods.

FREE UPS GROUND
Shipping on chop orders over \$100.

Chop-Friendly " Supply Items Ship Free
with Chop Orders over \$100

DECOR
MOULDING & SUPPLIES

Tel: 631-231-5959 • 1-800-937-1055
Fax : 631-231-5034 • 1-800-937-0006
www.decormoulding.com
order@decormoulding.com